

**DAMAGE CONTROL
REPAIR STATION**

**TOOLS and EQUIPMENT
(3DCRS)**

AEL Range: 2-880044203

DAMAGE CONTROL REPAIR STATION TOOLS & EQUIPMENT (3DCRS)

Quantity
Required

BAG, LINEMAN TOOL -

NSN 5140-00-288-7763

WT. 3.1 lbs

VOL. 594.0 in³

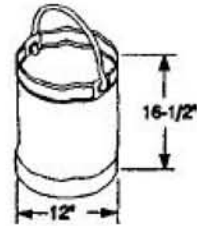

1

Helpful Hints:

Utilize any size storage bag onboard. Not to exceed 18" in dia./width. Order this as a replacement.

Actual Inventory:

BAG-TOOL SACHEL -

NSN 5140-00-293-2379

WT. 3.9 lbs

VOL. 11,248.0 in³



1

Helpful Hints:

Utilize any size storage bag onboard. Not to exceed 18" in dia./width. Order this as a replacement.

Actual Inventory:

BATTERY (AA) - NON RECHARGEABLE - 1.5 VOLTS

NSN 6135-00-985-7845

WT. 0.1

VOL. 0.5 in³



1
pkg

Helpful Hints: Ten (10) for thermal imager and four (4) for Stealth Light.
Insert in battery cartridge box. One package contains 24 batteries.

Actual Inventory:

BATTERY C CELL

NSN 6135-00-935-7846

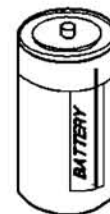

1
pkg

Helpful Hints : 12 per pkg. Used for Saber Flashlight

Actual Inventory:

DAMAGE CONTROL REPAIR STATION TOOLS & EQUIPMENT (3DCRS)

Quantity
Required

BATTERY D CELL - 1.5 VOLTS

NSN 6135-00-835-7210

WT. 0.5 lbs

VOL. 3.5 in³

DELETE

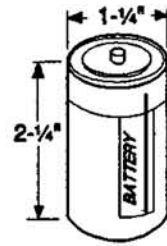

1
pkg

Helpful Hints: Alkaline. For flashlight use. (12 per pkg.)

Actual Inventory:

BATTERY DRY CELL - 9 VOLTS

NSN 6135-00-900-2139

WT. 2.0 oz

VOL. 0.9 in³

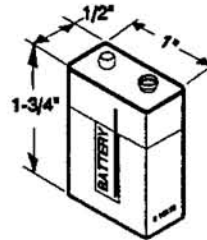

1
pkg

Helpful Hints: Alkaline. For Voice Amplifier and Fire Finder. (12 per pkg.)

Actual Inventory:

**CABLE - ASSEMBLY
CASUALTY POWER
75 FT**

1HM0000-LL-CQA-0078

WT. 60.0 lbs

VOL. 6,950.0 in³

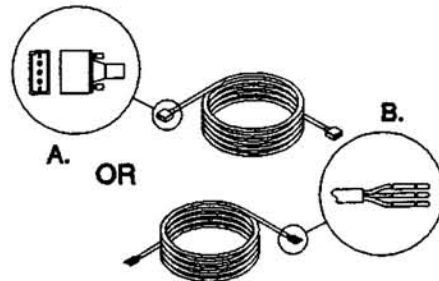

Helpful Hints: Only 1 casualty power cable required per DCRS. It should be stowed in P-way and identified for DCRS & length at the stowage rack label plate.

- A. Casualty power system (MIL-T-24552 new style)
- B. Casualty power system (MIL-T-24381, three prong, old style)

Actual Inventory:

DAMAGE CONTROL REPAIR STATION TOOLS & EQUIPMENT (3DCRS)

Quantity
Required

CABLE - ASSEMBLY
POWER ELEC

6450-00-449-1189

WT. 6 lbs

VOL. 6,950.0 in³



2

Helpful Hints:

Actual Inventory:

CARTRIDGE - BATTERY

6160-01-305-5890

WT. 1.0 lbs

VOL. 20.0 in³

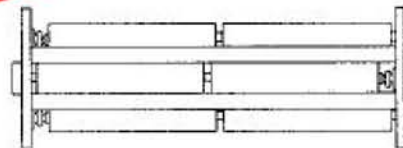

1

Helpful Hints: For thermal imager. Pack holds ten 1.5V (AA) batteries. New battery pack will operate NFTI for approx 1-1/2 hours.

Actual Inventory:

CASUALTY POWER - DANGER -
HIGH VOLTAGE SIGN

1HS0000-LL-CJ7-5883
(PACKAGE OF 20)

WT. 1.0 lbs.

VOL. 72.0 in³

DELETE



10

Helpful Hints:

MOVED TO ELECTRICAL REPAIR KIT

Actual Inventory:

DAMAGE CONTROL REPAIR STATION TOOLS & EQUIPMENT (3DCRS)

Quantity
Required

CASUALTY POWER - WRENCH

5120-00-241-3181

WT. 0.5 lbs.

VOL. 6.5 in³

Helpful Hints: Used with old style casualty power system.

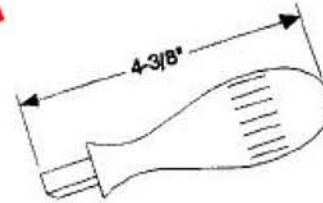

1

Actual Inventory:

CHEST TOOL KIT - 23" x 9" x 11"

NSN 5140-00-369-4927

WT. 6.0 lbs.

VOL. 2,277.0 in³

Helpful Hints:

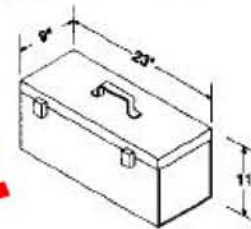

3
ea

Actual Inventory:

CONNECTOR PLUG - ELECTRIC
CASUALTY POWER SYS

5935-01-005-6401

WT. 1.2 lbs.

VOL. 52.5 in³

Helpful Hints: Used with casualty power system. MIL-T-24552. New style system only.

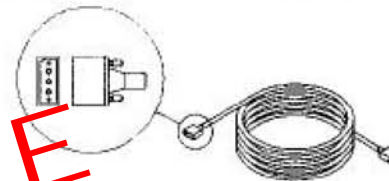

AR

Actual Inventory:

DAMAGE CONTROL REPAIR STATION TOOLS & EQUIPMENT (3DCRS)

Quantity
Required

EXTINGUISHER - AFFF
2.5 gal

NSN 4210-01-147-1091 - EXTINGUISHER
NSN 4210-01-112-1097 - BRACKET

WT. 28.0 lbs. VOL. 1176.0 in.³

Helpful Hints: 2.5 gallon AFFF extinguisher.
Will replace the CO₂ 15 lb. portable
extinguisher in the DCRS as funds are
available.

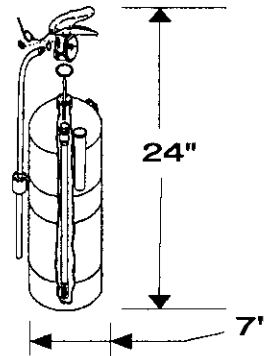

2

Actual Inventory:

EXTINGUISHER - FIRE
CO₂ 15 LB. PORTABLE
SHIPBOARD USE.

NSN 4210-00-203-0217

WT. 50.0 lbs. VOL. 3000.0 in.³

Helpful Hints:

It should be relocated to passageway to provide immediate access to repair party personnel.
PMS due date _____. M type ships have option to order non-magnetic
extinguishers.

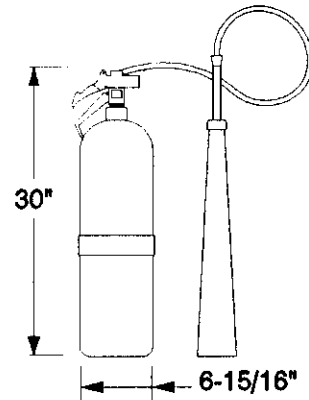

2

Actual Inventory:

DAMAGE CONTROL REPAIR STATION TOOLS & EQUIPMENT (3DCRS)

Quantity
Required

EXTINGUISHER - FIRE
PKP - 18 LB. PORTABLE
MAGNETIC

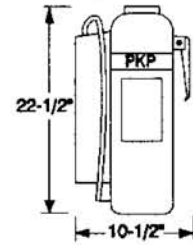

1

NSN 4210-00-989-4589

WT. 52.5 lbs.

VOL. 3,632.8 in.³

Helpful Hints:

It should be relocated to passageway to provide immediate access for Repair Party Personnel. PMS due date _____. M type ships have the option to order non-magnetic PKP extinguisher.

Actual Inventory:

FLANGES - BLANK

1" TO 4"
ASSORTED SIZES
MANUFACTURED BY SHIPS FORCE
GEN NOTE: NOT FOR USE IN LINES
EXCEEDING 400 PSI.

(4 BOLTS, 8 BOLTS
PATTERN MAY BE
USED.)

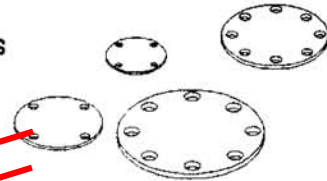

10
total

1HS0000-LL-CJ7-5885

WT. 102.8 lbs.

VOL. 85.0 in.³

6-1/8" DIA.,
SIZE TYPICAL,
THICKNESS VARIOUS

Helpful Hints:

Select flange sizes to accommodate piping systems in DCRS zone of responsibility. NAVSEA dwg #804-5959235.

Actual Inventory:

FLASHLIGHT - WATERPROOF
WITHOUT "D" CELL BATTERIES
WITH 2 LAMPS, 1 SPOT AND 1 DIFFUSING.
2 FILTERS, 1 BLACKOUT AND 1 RED LENS.

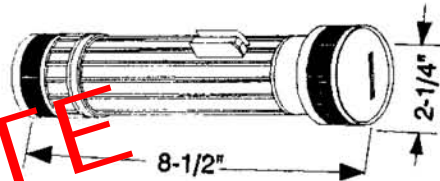

6

NSN 6230-00-270-5418

WT. 3.0 oz

VOL. 43.1 in.³

Helpful Hints:

Actual Inventory:

FLASHLIGHT - INVESTIGATOR

NSN 6230-01-281-3775

WT. 1.5 lbs

VOL. 62.5 in.³

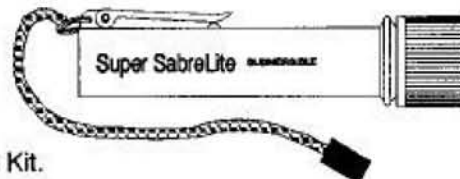

Helpful Hints: Two per DCRS. Stow with Investigator's Kit.

Actual Inventory:

DAMAGE CONTROL REPAIR STATION TOOLS & EQUIPMENT (3DCRS)

Quantity
Required

KIT - FIRST AID

NSN 6545-00-116-1410

WT. 10.0 lbs. VOL. 26.9 in³

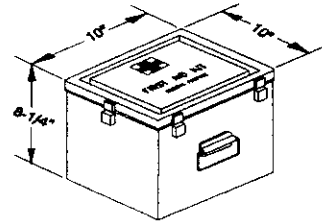

1

Helpful Hints:

A laminated kit inventory should be with this kit.

Actual Inventory:

KIT - VARIOUS DAMAGE CONTROL

NSN VARIOUS

WT. VARIOUS lbs. VOL. VARIOUS in³

ind.
kit

Helpful Hints: See Kit section for specific kit contents.

Actual Inventory:

**PATCH-BOX - VARIOUS SIZES
REPAIR PARTY MANUAL 7104.L**

1HS0000-LL-CJ7-5880

(ILLUSTRATED
LARGEST SIZE)

ASSY 1:

WT. 24.1 lbs. VOL. 1,200.0 in³

ASSY 2:

WT. 34.3 lbs VOL. 2,730.0 in³

ASSY 3:

WT. 51.5 lbs VOL. 5,136.0 in³

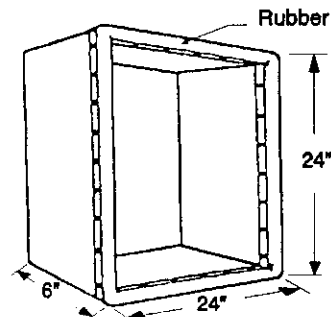

4
total

Helpful Hints:

Can be stowed in DCRS or passageway near shoring rack if possible. Three assemblies provided of various sizes to be manufactured by ship's force - edges with gaskets: made of wood, aluminum or steel. Use with required J,T or L bolts. NAVSEA dwg #804-5959236. Select 1 each from assemblies 1 & 2, and 2 each from assembly 3.

Actual Inventory:

DAMAGE CONTROL REPAIR STATION TOOLS & EQUIPMENT (3DCRS)

Quantity
Required

**PATCH-BUCKET -
NOTE:**

1HS0000-LL-CJ7-5881

WT. 2.0 lbs.

VOL. 1,320.0 in³

DELETE

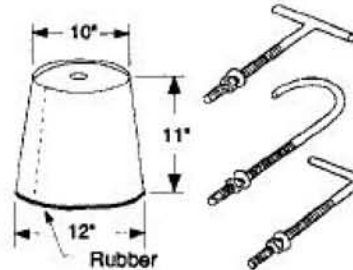

2
total

Helpful Hints:

To be manufactured by ship's force. Use metal bucket with 1/2" gasket material on edge. Use with J, T or L bolts. See plate patch for table J, T, & L bolts sizes/weights. NAVSEA Dwg #804-5959243.

Actual Inventory:

**PATCH - JUBILEE PIPE PATCHES
INCLUDING GASKET MATERIAL AND CARRIAGE BOLTS AND NUTS
1HS0000-LL-CJ7-5897**

ASSY 1 one piece assy for pipe sizes 6";8" & 12"

WT. 2.0 lbs APPROX

VOL. 768.0 in³

ASSY 2 two piece assy for pipe sizes 1/2";2";4";6";8" & 12"

WT. 2.5 lbs APPROX

VOL. 432.0 in³

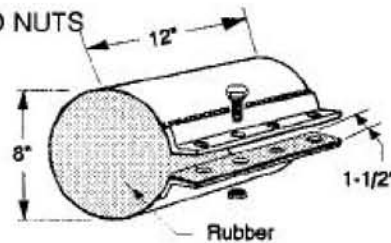

8
total

Helpful Hints: To be manufactured by ship's force. NAVSEA dwg #804-5959240. Note: Small patches can be stowed inside large patch. Select 8 patches from assemblies 1 & 2 to accommodate piping in DCRS zone. Stow in tool satchel bag with appropriate wrenches for nuts/bolts. Stencil "JUBILEE PIPE PATCH KIT" in 1" letters. Stow with pipe patching materials.

Actual Inventory:

DAMAGE CONTROL REPAIR STATION TOOLS & EQUIPMENT (3DCRS)

Quantity
Required

PATCH - PLATE PATCHES
WITH BOLTS T-J-L BOLTS
1HS0000-LL-CJ7-5892

SQUARE PLATE PATCHES:

PATCH #1 (6" sq.) WT. 2.6 lbs
PATCH #2 (12" sq.) WT. 10.3 lbs
PATCH #3 (18" sq.) WT. 23.3 lbs
PATCH #4 (24" sq.) WT. 41.3 lbs

FOLDING PLATE PATCHES:

PATCH #1 (10" dia) WT. 7.6 lbs
PATCH #2 (14" dia) WT. 13.9 lbs
PATCH #3 (18" dia) WT. 21.9 lbs

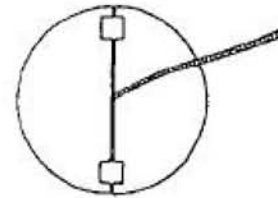

4
total

WT. 2.6 lbs. VOL. various

Helpful Hints: Manufactured by ship's force. Refer to NAVSEA dwg #804-5959239. Can be stowed in DCRS or passageway within area of responsibility preferably near shoring rack.

Actual Inventory:

PP-AUDIO PROJ VOICE AMP -

NSN 5830-01-350-6428

WT. 2.3 lbs. VOL.



18
total

Helpful Hints: Delete requirement when ship is outfitted with SCBA.

Actual Inventory:

DAMAGE CONTROL REPAIR STATION TOOLS & EQUIPMENT (3DCRS)

Quantity
Required

PP-BOOTS - FIREMAN

1H 0000-LL-CJ6-8462 SELECT SIZE

- NSN 8430-00-753-5935 SIZE 05
- NSN 8430-00-753-5936 SIZE 06
- NSN 8430-00-753-5937 SIZE 07
- NSN 8430-00-753-5938 SIZE 08
- NSN 8430-00-753-5939 SIZE 09
- NSN 8430-00-753-5940 SIZE 10
- NSN 8430-00-753-5941 SIZE 11
- NSN 8430-00-753-5942 SIZE 12
- NSN 8430-00-753-5943 SIZE 13
- NSN 8430-00-753-5944 SIZE 14
- NSN 8430-00-753-5945 SIZE 15

(PAIR)

WT. 6.7 lbs

VOL. 3,935.2 in³

12

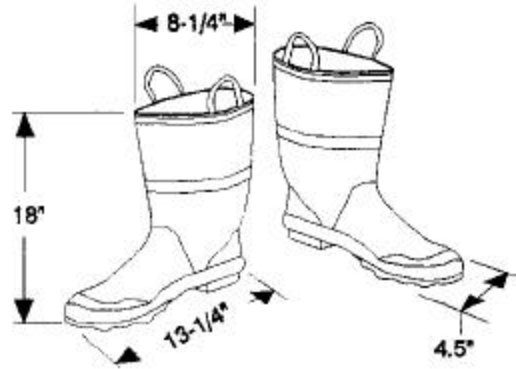

Helpful Hints: Each OBA should have boots available. Can be stowed with OBAs or in DCRS. Fireman boots are authorized for use by Repair Party Electricians (Nov 86 NAVSHIPS Safety Bulletin).

Actual Inventory:

PP-BOOTS - HIP

- NSN 8430-00-147-1036 SIZE 10
- NSN 8430-00-147-1038 SIZE 12

WT. 8.0 lbs

VOL. 3,935.2 in³



3

Helpful Hints: Size 10 = 2 pair.
 Size 12 = 1 pair.

DELETE

Actual Inventory:

DAMAGE CONTROL REPAIR STATION TOOLS & EQUIPMENT (3DCRS)

Quantity
Required

PP-BREATHING APPARAT - OBA A-4

NSN 4240-01-297-5986

WT. 15.5 lbs

VOL. 3,366.0 in³

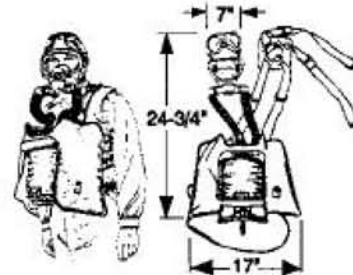

18

Helpful Hints: For repair parts see APL 990010075. Delete requirement when ship is outfitted with SCBA.

Actual Inventory:

**PP-CANISTER - OXYGEN GEN
(GREEN)**

NSN 4240-00-174-1365

(BOX OF 6 CANISTERS)

WT. 4.0 lbs

VOL. 178.1 in³

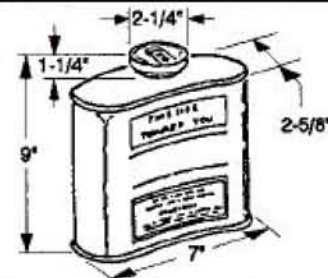

216
total

Helpful Hints: Allowance of canisters for all ships is twelve each for one breathing apparatus, six as ready service and six as reserve. Ready service canisters shall be stowed with their respective OBAs. Reserve canisters shall be stowed in repair stations, weather access reentry stowage spaces or other readily accessible locations on or above the damage control deck as approved by the supervisor. Reserve canisters may be stowed in their original shipping containers. Canisters for shipboard use must be equipped with canister cap to protect the OBA seal. Delete requirement when ship is outfitted with SCBA.

Number ready for use (6 canister/OBA):

Number of unopened cases (1 box/canister OBA):

PP-CAP OBA CANISTER -

A2 PC CAP

NSN 4240-00-089-7963

(10 CAPS PER BOX)

WT. 0.5 lbs

VOL. 23.5 in³

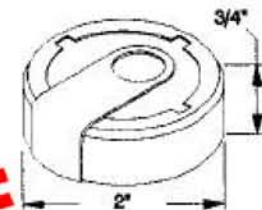

1
box

Helpful Hints: Cap is used to protect OBA seal.

DELETE

Actual Inventory:

DAMAGE CONTROL REPAIR STATION TOOLS & EQUIPMENT (3DCRS)

Quantity
Required

PP-COVERALL - FIRE RET

25

MEN'S

- NSN 8405-01-286-6336 SIZE 36S
- NSN 8405-01-286-6337 SIZE 36R
- NSN 8405-01-286-6338 SIZE 38S
- NSN 8405-01-286-6339 SIZE 38R
- NSN 8405-01-286-6340 SIZE 38L
- NSN 8405-01-286-6341 SIZE 40S
- NSN 8405-01-286-6342 SIZE 40R
- NSN 8405-01-286-6343 SIZE 40L
- NSN 8405-01-286-6344 SIZE 42S
- NSN 8405-01-286-6345 SIZE 42R
- NSN 8405-01-286-6346 SIZE 42L
- NSN 8405-01-286-6347 SIZE 44S
- NSN 8405-01-286-6348 SIZE 44R
- NSN 8405-01-286-6349 SIZE 44L



- NSN 8405-01-286-6350 SIZE 46S
- NSN 8405-01-286-6351 SIZE 46M
- NSN 8405-01-286-6352 SIZE 46L
- NSN 8405-01-286-6353 SIZE 48R
- NSN 8405-01-286-6354 SIZE 48L

WT. AVG 1.0 LB

VOL. AVG 108.0 in³ (FOLDED 18"X12"X1/2")

Helpful Hints:

Actual Inventory:

PP-GLOVES - ANTIFLASH

NSN 8415-01-267-9661
(PAIR)

WT. 1.0 oz

VOL. 11.3 in³

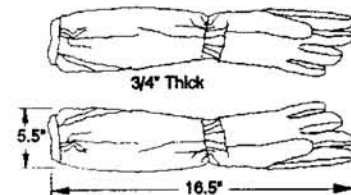

25

Helpful Hints: Stored with life preserver and antflash hood. Part of G.Q. gear.

Actual Inventory:

DAMAGE CONTROL REPAIR STATION TOOLS & EQUIPMENT (3DCRS)

Quantity
Required

**PP-GLOVES - RUBBER
7500 VOLT**

**NSN 8415-01-158-9450
(PAIR)
WT. 1.0 lb**

DELETE

VOL. 77.0 in³

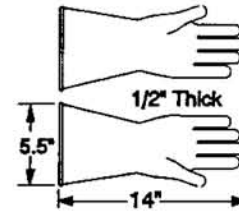

2
pair

Helpful Hints: Gloves, electrical. These gloves were a recommendation from the safety center in 1988. Added to inventory, in addition to those in the electrical repair kit.

Actual Inventory:

PP-GLOVES - SHELL ELEC

**NSN 8415-00-264-3618
(PAIR)
WT. 1.5 lbs**

DELETE

VOL. 84.0 in³

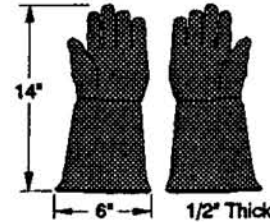

2
pair

Helpful Hints: The shell protects the rubber gloves. Recommended by Safety Center in 1988. Added to inventory, in addition to those in the electrical repair kit.

Actual Inventory:

PP-GLOVES - FIREMAN

**1HM0000-LL-CQA-2201 SELECT SIZE
NSN 8415-01-421-1368 SIZE SML
NSN 8415-01-421-1371 SIZE MED
NSN 8415-01-421-1373 SIZE LRG
NSN 8415-01-421-1375 SIZE X-LRG
NSN 8415-01-421-1376 SIZE XX-LRG
(PAIR)
WT. 2.0 lbs. VOL. 108.0 in³**

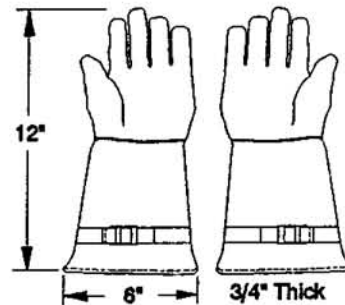

12
pair

Helpful Hints: Used for each OBA. Replace stock when worn with new firefighter's glove. Procure gloves IAW MIL-G-24934/National Fire Protection Association (NFPA) standards.

Actual Inventory:

DAMAGE CONTROL REPAIR STATION TOOLS & EQUIPMENT (3DCRS)

Quantity
Required

PP-HELMET - FIREMAN



25

NSN 8415-01-271-8069

WT. 2.9 lbs

VOL. 1,320.0 in³

Helpful Hints: Stored in helmet rack in passageway, on hook, butterfly clips or designated stowage device. Protect visor. The visor is essential for pipe patching to protect the eyes from water spray.

Actual Inventory:

**PP-HELMET - PHONE TALKER
MARK 4 MOD 0**

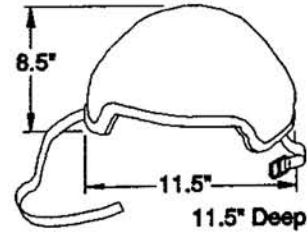

2

NSN 8470-01-127-7337

WT. 4.0 lbs.

VOL. 1,124.0 in³

Helpful Hints: Stored in phone talker helmet rack in main DCRS or passageway.

Actual Inventory:

PP-HOOD - ANTIFLASH

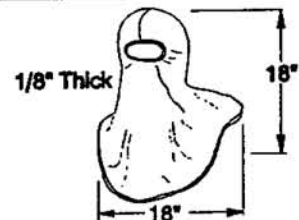

25

NSN 4210-01-493-4694

WT. 2.0 oz

VOL. 20.2 in³

Helpful Hints: Stow with life preserver and antiflash gloves. Part of G.Q. gear.

Actual Inventory:

DAMAGE CONTROL REPAIR STATION TOOLS & EQUIPMENT (3DCRS)

Quantity
Required

PP-LANTERN HEAD - (USES FOUR SIZE AA BATTERIES)

NSN 6135-00-985-7845 SIZE AA BATTERIES
NSN 6230-01-285-4396 ASSEMBLY
PHILLIPS HPR-40 OR REPLACEMENT
OSRAM 640721 HALOGEN BULB



12

WT. 1.0 lbs VOL. 117.0 in³

Helpful Hints: All kit lanterns moved to parent AEL. AA batteries supplied in package of 24. Two boxes required to outfit head lanterns.

Actual Inventory:

PP-LIFE PRESRVR - Y INFLAT

NSN 4220-00-289-1891

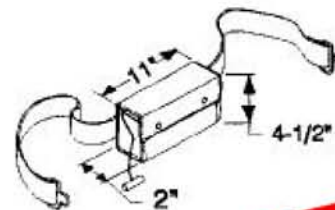

25

WT. 3.0 lbs. VOL. 60.0 in³

Helpful Hints: Should be stored with general quarters gear in passageway locker.



Actual Inventory:

PP-POWDER - TALC

NSN 8510-00-817-0295

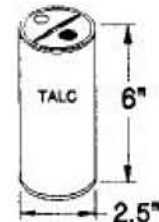

1

WT. 6.0 oz VOL. 37.5 in³

Helpful Hints:

Actual Inventory:

DAMAGE CONTROL REPAIR STATION TOOLS & EQUIPMENT (3DCRS)

Quantity
Required

THERMAL IMAGER -

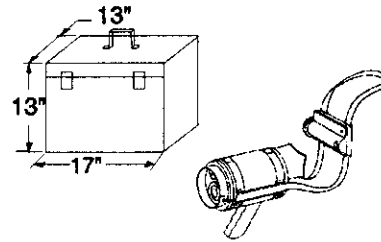

1

NSN 4210-01-213-7310

WT. 29.0 lbs. VOL. 2,873.0 in³

Helpful Hints: APL - 2930094090. Ten AA batteries are inserted into the battery cartridge to operate.

Actual Inventory: