

**S5090-BL-DCB-010A
INVENTORY AID BOOKLET
FOR DAMAGE CONTROL EQUIPMENT**

9 November 2004

INSERT LATEST CHANGED PAGES, DESTROY SUPERSEDED PAGES.

LIST OF EFFECTIVE PAGES

NOTE: The portion of the text affected by the changes is indicated by a vertical line in the outer margin of the page. Changes to illustrations are indicated by miniature pointing hands. Changes to wiring diagrams are indicated by shaded areas.

Dates of issue for original and changed pages are:
 Original 0 31 March 1996
 Change A 9 November 2004

TOTAL NUMBER OF PAGES IN THIS PUBLICATION IS 279 CONSISTING OF THE FOLLOWING:

<u>Page No.</u>	<u>*Change No.</u>	<u>Page No.</u>	<u>*Change No.</u>
Title	0	21-0-21-4	A
i-vi	0	22-0-22-7	0
1-0-1-16	A	23-0-23-7	A
2-0-2-7	A	24-0-24-5	0
3-0-3-3	0	25-0-25-7	A
4-0-4-4	0	26-0-26-6	A
5-0-5-5	0	27-0-27-3	A
6-0-6-2	A	28-0-28-11	A
7-0-7-13	0	29-0-29-5	0
8-0-8-4	A	30-1-30-2	A
9-0-9-6	A	31-1-31-7	A
10-0-10-3	0	32-0-32-4	A
11-0-11-9	A	33-0-33-1	0
12-0-12-2	0	34-0-34-6	0
13-0-13-3	A	35-0-35-9	A
14-0-14-2	A	36-0-36-11	A
15-0-15-9	A	37-0-37-11	A
16-0-16-6	A	38-0-38-4	0
17-0-17-3	A	39-0-39-5	A
18-0-18-4	A	40-0-40-13	0
19-0-19-4	A	Recommendation/Suggestion Form	0
20-0	0		

*Zero in this column indicates an original page.

**DAMAGE CONTROL EQUIPMENT INVENTORY AID BOOKLET
RECORD OF CHANGES**

Change No.	Date of Change	Title or Brief Description	Entered By

DAMAGE CONTROL EQUIPMENT INVENTORY AID BOOKLET

INTRODUCTION

The Damage Control Equipment Inventory Aid Booklet was prepared by the Naval Sea Systems Command in response to an action item of the Chief of Naval Operation's Damage Control/Fire Fighting Working Group (DC/FF WG). The purpose of this booklet is to assist shipboard damage control personnel in identification, inventory, organization and maintenance of damage control equipment. This booklet also provides a valuable reference document for conducting onboard training and to answer questions about using Damage Control Allowance Equipment Lists (AELs).

This booklet provides damage control equipment illustrations listed in alphabetical order for a 3 DCRS ship parent AEL, DC Unit Patrol Locker (DCUL), DC Unit Patrol Station (DCUPS) and the Rescue and Assistance/Reentry Locker (DCREL). These are followed by sketches of the DC Kit AELs. Each item identifies the quantity and has a Helpful Hints statement which provides additional guidance on stowage and outfitting for the respective item. Most ships within the fleet have 3 DCRS. It is recommended that ships utilize this booklet.

We recommend that a hard copy of the ship's AELs be placed with each kit in the booklet for use as a ready inventory reference. This inventory aid will be updated via change pages for improvements and as equipment is added or deleted to damage control inventories. Damage control personnel are authorized to make copies of this booklet to assist with shipboard DC repair station inventories.

Please forward any comments or suggestions for improvements to: Commander, Code 03G1, Naval Sea Systems Command, 2531 Jefferson Davis Hwy, Arlington, VA. 22242-5160. Telephone: Commercial (703) 602-9295, DSN 332-9295, FAX (703) 602-5089.

Recommendations for improvements to this document are welcomed and will be presented annually through the DC/FF Working Group.

CONTENTS

The Fleet Damage Control Kit AELs establish requirements for standardization of damage control tools and equipment. The Kit AELs are organized in alphabetical order by damage control function so that tools and equipment serving the Kit AELs are organized numerically. The last two digits after the comma indicate AEL numbers of additional kits.

FLEET KIT AELS FOR DAMAGE CONTROL TOOLS & EQUIPMENT

<u>SECTION</u>	<u>TITLE</u>	<u>AEL NUMBER</u>	<u>PAGE</u>
1.	Damage Control Repair Station Tools & Equipment (3 DCRS)	2-880044203	1-0
2.	Adapters/Connections Kit	2-880044224,25	2-0
3.	Banding Tool Kit	2-880044223,26	3-0
4.	CBR Equipment Kit	2-880044227,28	4-0
5.	CBR Personnel Kit	2-880044229,30,31	5-0
6.	Collective Protection System Repair Kit - DC	2-880044235	6-0
7.	Damage Control Petty Officer (DCPO) Tool Kit - DC	2-880044236,37	7-0
8.	Desmoking Equipment Kit - DC	2-880044238,39	8-0
9.	Dewatering Equipment Kit - DC	2-880044240	9-0
10.	Electrical Cable Repair Kit - DC	2-880044242	10-0
11.	Electrical Repair Kit - DC	2-880044243,44	11-0
12.	Electronic Repair Kit - DC	2-8800442	12-0

DELETE KIT

DELETE KIT

(PART OF SHIP TOTAL)

DELETE KIT

DELETE KIT

13.	Emergency Communication Kit - DC	2-880044246,47	13-0
14.	Emergency Lighting Kit - DC	2-880044248,49	14-0
15.	Engineering Spaces Kit - DC	2-880044250,51	15-0
16.	Fire Fighting/Access Equipment Kit - DC	2-880044252,53	16-0
17.	Fire Fighting/Access Personnel Kit - DC	2-880044254,55	17-0
18.	Gas Free Engineer Kit - DC	2-880044260,61	18-0
19.	Investigator Kit - DC	2-880044262,63	19-0
20.	Low Pressure Boundary Cooling Kit - DC	2-880044264,65	DELETE KIT	20-0
21.	Monitoring Team Kit - DC	2-880044266,67	21-0
22.	Pipe Patching Kit - DC	2-880044268,69	22-0
23.	Portable Pump	2-8800044270	23-0
24.	Plastic Patch/Pipe Repair Kit - DC	2-880044222,71	24-0
25.	Plugging Kit - DC	2-880044272,73	25-0
26.	Portable Exothermic Cutting Unit (PECU) Kit - DC	2-880044274,75	26-0
27.	Portable Access Rescue System (PARs)	2-880044276	27-0
28.	Repair Locker Tool Kit - DC	2-880044277,78	28-0
29.	Rescue and Assistance Chests Kit	2-880044279	29-0
30.	Shoring Material Kit - DC	2-880044280,81	30-0
31.	Shoring Tool Kit - DC	2-880044282,83	31-0

32.	Sounding Kit - DC	2-880044284,85 . DELETE .KIT. .	32-0
33.	Training Kit - DC	2-880044286	33-0
34.	Welding Equipment Kit - DC	2-880044287,88	34-0
35.	Damage Control Unit Locker (DCUL)	2-880044212	35-0
36.	Damage Control Unit Patrol Station (DCUPS)	2-880044216	36-0
37.	Rescue and Assistance Reentry Locker - DC	2-880044218	37-0
38.	Shoring Supplement Kit - DC (MHC 51 Class only)	2-880044289	38-0
39.	Safety/Survivability NDI Equipment	2-880044298, 99	39-0
40.	Deleted Items from DCRS Equipment		40-0

**DAMAGE CONTROL
REPAIR STATION**

**TOOLS and EQUIPMENT
(3DCRS)**

AEL Range: 2-880044203

DAMAGE CONTROL REPAIR STATION TOOLS & EQUIPMENT (3DCRS)

Quantity
Required

BAG, LINEMAN TOOL -

NSN 5140-00-288-7763

WT. 3.1 lbs

VOL. 594.0 in³

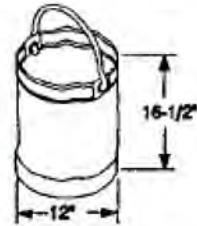

1

Helpful Hints:

Utilize any size storage bag onboard. Not to exceed 18" in dia./width. Order this as a replacement.

Actual Inventory:

BAG-TOOL SACHEL -

NSN 5140-00-293-2379

WT. 3.9 lbs

VOL. 11,248.0 in³



1

Helpful Hints:

Utilize any size storage bag onboard. Not to exceed 18" in dia./width. Order this as a replacement.

Actual Inventory:

BATTERY (AA) - NON RECHARGEABLE - 1.5 VOLTS

NSN 6135-00-985-7845

WT. 0.1

VOL. 0.5 in³



1
pkg

Helpful Hints: Ten (10) for thermal imager and four (4) for Stealth Light. Insert in battery cartridge box. One package contains 24 batteries.

Actual Inventory:

BATTERY C CELL

NSN 6135-00-935-7846

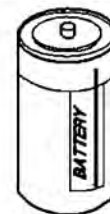

1
pkg

Helpful Hints : 12 per pkg. Used for Saber Flashlight

Actual Inventory:

DAMAGE CONTROL REPAIR STATION TOOLS & EQUIPMENT (3DCRS)

Quantity
Required

BATTERY D CELL - 1.5 VOLTS

NSN 6135-00-835-7210

WT. 0.5 lbs

VOL. 3.5 in³

DELETE

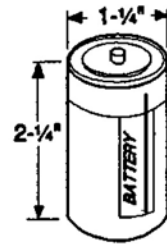

1
pkg

Helpful Hints: Alkaline. For flashlight use. (12 per pkg.)

Actual Inventory:

BATTERY DRY CELL - 9 VOLTS

NSN 6135-00-900-2139

WT. 2.0 oz

VOL. 0.9 in³

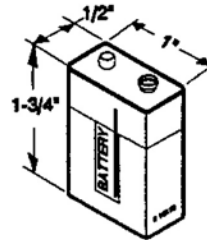

1
pkg

Helpful Hints: Alkaline. For Voice Amplifier and Fire Finder. (12 per pkg.)

Actual Inventory:

**CABLE - ASSEMBLY
CASUALTY POWER
75 FT**

1HM0000-LL-CQA-0078

WT. 60.0 lbs

VOL. 6,950.0 in³

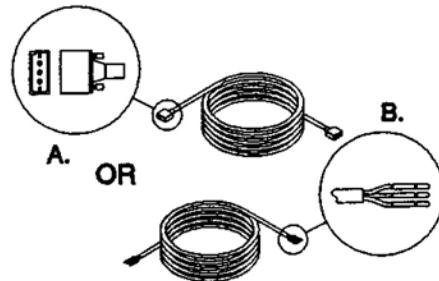

Helpful Hints: Only 1 casualty power cable required per DCRS. It should be stowed in P-way and identified for DCRS & length at the stowage rack label plate.

- A. Casualty power system (MIL-T-24552 new style)
- B. Casualty power system (MIL-T-24381, three prong, old style)

Actual Inventory:

DAMAGE CONTROL REPAIR STATION TOOLS & EQUIPMENT (3DCRS)

Quantity
Required

CABLE - ASSEMBLY
POWER ELEC

6450-00-449-1189

WT. 6 lbs

VOL. 6,950.0 in³



2

Helpful Hints:

Actual Inventory:

CARTRIDGE - BATTERY

6160-01-305-5890

WT. 1.0 lbs

VOL. 20.0 in³

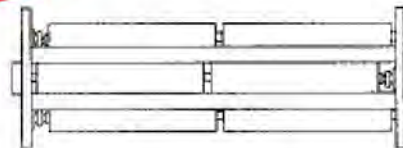

1

Helpful Hints: For thermal imager. Pack holds ten 1.5V (AA) batteries. New battery pack will operate NFTI for approx 1-1/2 hours.

Actual Inventory:

CASUALTY POWER - DANGER -
HIGH VOLTAGE SIGN

1HS0000-LL-CJ7-5883
(PACKAGE OF 20)

WT. 1.0 lbs.

VOL. 72.0 in³



10

Helpful Hints:

MOVED TO ELECTRICAL REPAIR KIT

Actual Inventory:

DAMAGE CONTROL REPAIR STATION TOOLS & EQUIPMENT (3DCRS)

Quantity
Required

CASUALTY POWER - WRENCH

5120-00-241-3181

WT. 0.5 lbs.

VOL. 6.5 in³

Helpful Hints: Used with old style casualty power system.

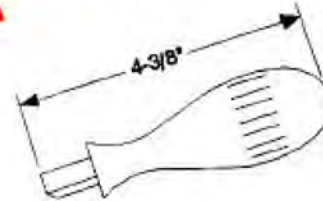

1

Actual Inventory:

CHEST TOOL KIT - 23" x 9" x 11"

NSN 5140-00-369-4927

WT. 6.0 lbs.

VOL. 2,277.0 in³

Helpful Hints:

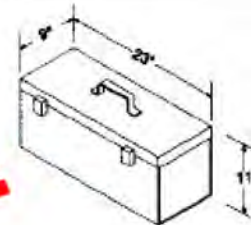

3
ea

Actual Inventory:

CONNECTOR PLUG - ELECTRIC
CASUALTY POWER SYS

5935-01-005-6401

WT. 1.2 lbs.

VOL. 52.5 in³

Helpful Hints: Used with casualty power system. MIL-T-24552. New style system only.

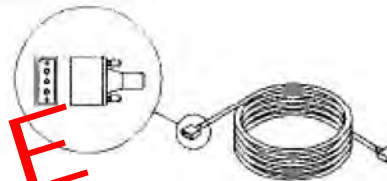

AR

Actual Inventory:

DAMAGE CONTROL REPAIR STATION TOOLS & EQUIPMENT (3DCRS)

Quantity
Required

EXTINGUISHER - AFFF
2.5 gal

NSN 4210-01-147-1091 - EXTINGUISHER
NSN 4210-01-112-1097 - BRACKET

WT. 28.0 lbs. VOL. 1176.0 in.³

Helpful Hints: 2.5 gallon AFFF extinguisher.
Will replace the CO₂ 15 lb. portable
extinguisher in the DCRS as funds are
available.

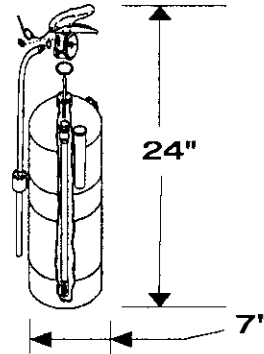

2

Actual Inventory:

EXTINGUISHER - FIRE
CO₂ 15 LB. PORTABLE
SHIPBOARD USE.

NSN 4210-00-203-0217

WT. 50.0 lbs. VOL. 3000.0 in.³

Helpful Hints:

It should be relocated to passageway to provide immediate access to repair party personnel.
PMS due date _____. M type ships have option to order non-magnetic
extinguishers.

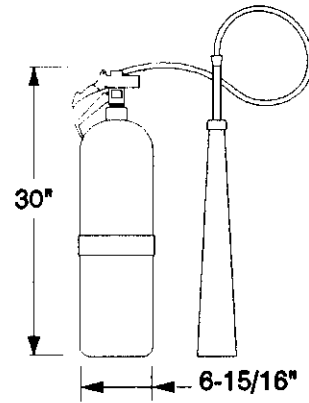

2

Actual Inventory:

DAMAGE CONTROL REPAIR STATION TOOLS & EQUIPMENT (3DCRS)

Quantity
Required

EXTINGUISHER - FIRE
PKP - 18 LB. PORTABLE
MAGNETIC

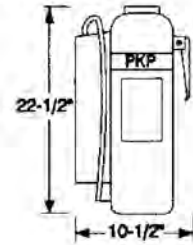

1

NSN 4210-00-989-4589

WT. 52.5 lbs.

VOL. 3,632.8 in.³

Helpful Hints:

It should be relocated to passageway to provide immediate access for Repair Party Personnel. PMS due date _____ M type ships have the option to order non-magnetic PKP extinguisher.

Actual Inventory:

FLANGES - BLANK

1" TO 4"

ASSORTED SIZES

MANUFACTURED BY SHIPS FORCE

GEN NOTE: NOT FOR USE IN LINES

EXCEEDING 400 PSI.

(4 BOLTS, 8 BOLTS
PATTERN MAY BE
USED.)

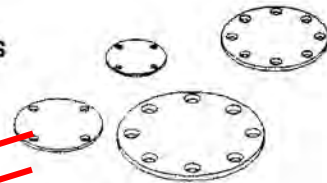

10
total

1HS0000-LL-CJ7-5885

WT. 102.8 lbs.

VOL. 85.0 in.³

6-1/8" DIA.,
SIZE TYPICAL,
THICKNESS VARIOUS

Helpful Hints:

Select flange sizes to accommodate piping systems in DCRS zone of responsibility. NAVSEA dwg #804-5959235.

Actual Inventory:

FLASHLIGHT - WATERPROOF

WITHOUT "D" CELL BATTERIES

WITH 2 LAMPS, 1 SPOT AND 1 DIFFUSING.

2 FILTERS, 1 BLACKOUT AND 1 RED LENS.

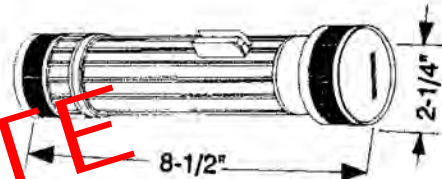

6

NSN 6230-00-270-5418

WT. 3.0 oz

VOL. 43.1 in.³

Helpful Hints:

Actual Inventory:

FLASHLIGHT - INVESTIGATOR

NSN 6230-01-281-3775

WT. 1.5 lbs

VOL. 62.5 in.³



Helpful Hints: Two per DCRS. Stow with Investigator's Kit.

Actual Inventory:

DAMAGE CONTROL REPAIR STATION TOOLS & EQUIPMENT (3DCRS)

Quantity
Required

KIT - FIRST AID

NSN 6545-00-116-1410

WT. 10.0 lbs. **VOL.** 26.9 in³

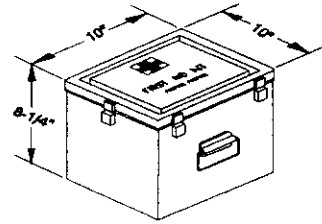

1

Helpful Hints:

A laminated kit inventory should be with this kit.

Actual Inventory:

KIT - VARIOUS DAMAGE CONTROL

NSN VARIOUS

WT. VARIOUS lbs. **VOL.** VARIOUS in³

ind.
kit

Helpful Hints: See Kit section for specific kit contents.

Actual Inventory:

**PATCH-BOX - VARIOUS SIZES
REPAIR PARTY MANUAL 7104.L**

1HS0000-LL-CJ7-5880

(ILLUSTRATED
LARGEST SIZE)

ASSY 1:

WT. 24.1 lbs. **VOL.** 1,200.0 in³

ASSY 2:

WT. 34.3 lbs **VOL.** 2,730.0 in³

ASSY 3:

WT. 51.5 lbs **VOL.** 5,136.0 in³

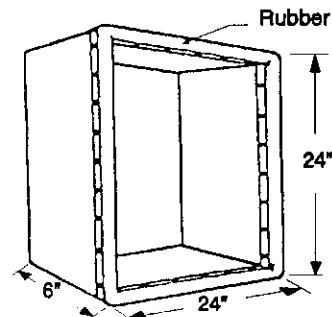

4
total

Helpful Hints:

Can be stowed in DCRS or passageway near shoring rack if possible. Three assemblies provided of various sizes to be manufactured by ship's force - edges with gaskets: made of wood, aluminum or steel. Use with required J,T or L bolts. NAVSEA dwg #804-5959236. Select 1 each from assemblies 1 & 2, and 2 each from assembly 3.

Actual Inventory:

DAMAGE CONTROL REPAIR STATION TOOLS & EQUIPMENT (3DCRS)

Quantity
Required

**PATCH-BUCKET -
NOTE:**

1HS0000-LL-CJ7-5881

WT. 2.0 lbs.

VOL. 1,320.0 in³

DELETE

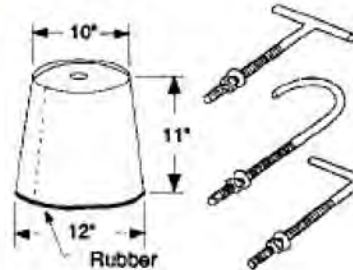

2
total

Helpful Hints:

To be manufactured by ship's force. Use metal bucket with 1/2" gasket material on edge. Use with J, T or L bolts. See plate patch for table J, T, & L bolts sizes/weights. NAVSEA Dwg #804-5959243.

Actual Inventory:

**PATCH - JUBILEE PIPE PATCHES
INCLUDING GASKET MATERIAL AND CARRIAGE BOLTS AND NUTS
1HS0000-LL-CJ7-5897**

ASSY 1 one piece assy for pipe sizes 6";8" & 12"

WT. 2.0 lbs APPROX

VOL. 768.0 in³

ASSY 2 two piece assy for pipe sizes 1/2";2";4";6";8" & 12"

WT. 2.5 lbs APPROX

VOL. 432.0 in³

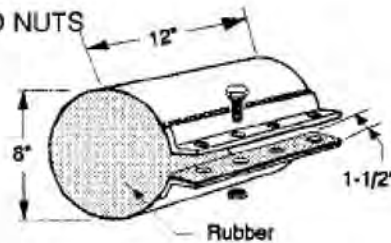

8
total

Helpful Hints: To be manufactured by ship's force. NAVSEA dwg #804-5959240. Note: Small patches can be stowed inside large patch. Select 8 patches from assemblies 1 & 2 to accommodate piping in DCRS zone. Stow in tool satchel bag with appropriate wrenches for nuts/bolts. Stencil "JUBILEE PIPE PATCH KIT" in 1" letters. Stow with pipe patching materials.

Actual Inventory:

DAMAGE CONTROL REPAIR STATION TOOLS & EQUIPMENT (3DCRS)

Quantity
Required

PATCH - PLATE PATCHES
WITH BOLTS T-J-L BOLTS
1HS0000-LL-CJ7-5892

SQUARE PLATE PATCHES:

PATCH #1 (6" sq.) WT. 2.6 lbs
PATCH #2 (12" sq.) WT. 10.3 lbs
PATCH #3 (18" sq.) WT. 23.3 lbs
PATCH #4 (24" sq.) WT. 41.3 lbs

FOLDING PLATE PATCHES:

PATCH #1 (10" dia) WT. 7.6 lbs
PATCH #2 (14" dia) WT. 13.9 lbs
PATCH #3 (18" dia) WT. 21.9 lbs

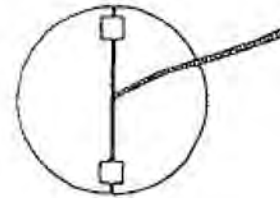

4
total

WT. 2.6 lbs. VOL. various

Helpful Hints: Manufactured by ship's force. Refer to NAVSEA dwg #804-5959239. Can be stowed in DCRS or passageway within area of responsibility preferably near shoring rack.

Actual Inventory:

PP-AUDIO PROJ VOICE AMP -

NSN 5830-01-350-6428

WT. 2.3 lbs. VOL.

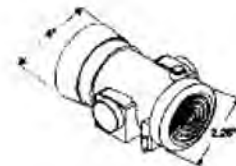

18
total

Helpful Hints: Delete requirement when ship is outfitted with SCBA.

Actual Inventory:

DAMAGE CONTROL REPAIR STATION TOOLS & EQUIPMENT (3DCRS)

Quantity
Required

PP-BOOTS - FIREMAN

1H 0000-LL-CJ6-8462 SELECT SIZE

- NSN 8430-00-753-5935 SIZE 05
- NSN 8430-00-753-5936 SIZE 06
- NSN 8430-00-753-5937 SIZE 07
- NSN 8430-00-753-5938 SIZE 08
- NSN 8430-00-753-5939 SIZE 09
- NSN 8430-00-753-5940 SIZE 10
- NSN 8430-00-753-5941 SIZE 11
- NSN 8430-00-753-5942 SIZE 12
- NSN 8430-00-753-5943 SIZE 13
- NSN 8430-00-753-5944 SIZE 14
- NSN 8430-00-753-5945 SIZE 15

(PAIR)

WT. 6.7 lbs

VOL. 3,935.2 in³

12



Helpful Hints: Each OBA should have boots available. Can be stowed with OBAs or in DCRS. Fireman boots are authorized for use by Repair Party Electricians (Nov 86 NAVSHIPS Safety Bulletin).

Actual Inventory:

PP-BOOTS - HIP

- NSN 8430-00-147-1036 SIZE 10
- NSN 8430-00-147-1038 SIZE 12

WT. 8.0 lbs

VOL. 3,935.2 in³

3



Helpful Hints: Size 10 = 2 pair.
Size 12 = 1 pair.

DELETE

Actual Inventory:

DAMAGE CONTROL REPAIR STATION TOOLS & EQUIPMENT (3DCRS)

Quantity
Required

PP-BREATHING APPARAT - OBA A-4

NSN 4240-01-297-5986

WT. 15.5 lbs

VOL. 3,366.0 in³



18

Helpful Hints: For repair parts see APL 990010075. Delete requirement when ship is outfitted with SCBA.

Actual Inventory:

**PP-CANISTER - OXYGEN GEN
(GREEN)**

NSN 4240-00-174-1365

(BOX OF 6 CANISTERS)

WT. 4.0 lbs

VOL. 178.1 in³

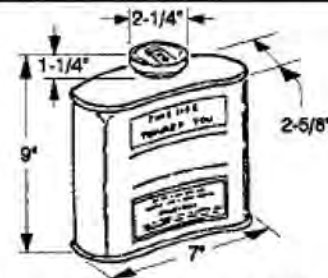

216
total

Helpful Hints: Allowance of canisters for all ships is twelve each for one breathing apparatus, six as ready service and six as reserve. Ready service canisters shall be stowed with their respective OBAs. Reserve canisters shall be stowed in repair stations, weather access reentry stowage spaces or other readily accessible locations on or above the damage control deck as approved by the supervisor. Reserve canisters may be stowed in their original shipping containers. Canisters for shipboard use must be equipped with canister cap to protect the OBA seal. Delete requirement when ship is outfitted with SCBA.

Number ready for use (6 canister/OBA):

Number of unopened cases (1 box/canister OBA):

PP-CAP OBA CANISTER -

A2 PC CAP

NSN 4240-00-089-7963

(10 CAPS PER BOX)

WT. 0.5 lbs

VOL. 23.5 in³



1
box

Helpful Hints: Cap is used to protect OBA seal.

DELETE

Actual Inventory:

DAMAGE CONTROL REPAIR STATION TOOLS & EQUIPMENT (3DCRS)

Quantity
Required

PP-COVERALL - FIRE RET

25

MEN'S

- NSN 8405-01-286-6336 SIZE 36S
- NSN 8405-01-286-6337 SIZE 36R
- NSN 8405-01-286-6338 SIZE 38S
- NSN 8405-01-286-6339 SIZE 38R
- NSN 8405-01-286-6340 SIZE 38L
- NSN 8405-01-286-6341 SIZE 40S
- NSN 8405-01-286-6342 SIZE 40R
- NSN 8405-01-286-6343 SIZE 40L
- NSN 8405-01-286-6344 SIZE 42S
- NSN 8405-01-286-6345 SIZE 42R
- NSN 8405-01-286-6346 SIZE 42L
- NSN 8405-01-286-6347 SIZE 44S
- NSN 8405-01-286-6348 SIZE 44R
- NSN 8405-01-286-6349 SIZE 44L

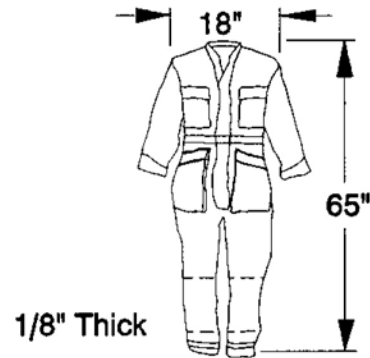

- NSN 8405-01-286-6350 SIZE 46S
- NSN 8405-01-286-6351 SIZE 46M
- NSN 8405-01-286-6352 SIZE 46L
- NSN 8405-01-286-6353 SIZE 48R
- NSN 8405-01-286-6354 SIZE 48L

WT. AVG 1.0 LB

VOL. AVG 108.0 in³ (FOLDED 18"X12"X1/2")

Helpful Hints:

Actual Inventory:

PP-GLOVES - ANTIFLASH

NSN 8415-01-267-9661
(PAIR)

WT. 1.0 oz

VOL. 11.3 in³

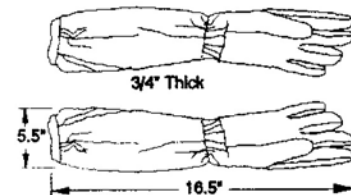

25

Helpful Hints: Stored with life preserver and antifeash hood. Part of G.Q. gear.

Actual Inventory:

DAMAGE CONTROL REPAIR STATION TOOLS & EQUIPMENT (3DCRS)

Quantity
Required

**PP-GLOVES - RUBBER
7500 VOLT**

**NSN 8415-01-158-9450
(PAIR)
WT. 1.0 lb**

DELETE

VOL. 77.0 in³

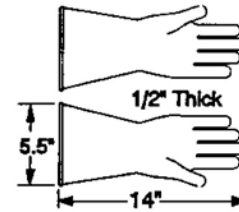

2
pair

Helpful Hints: Gloves, electrical. These gloves were a recommendation from the safety center in 1988. Added to inventory, in addition to those in the electrical repair kit.

Actual Inventory:

PP-GLOVES - SHELL ELEC

**NSN 8415-00-264-3618
(PAIR)
WT. 1.5 lbs**

DELETE

VOL. 84.0 in³

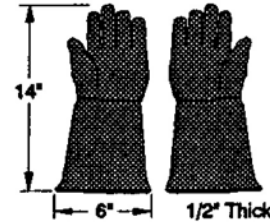

2
pair

Helpful Hints: The shell protects the rubber gloves. Recommended by Safety Center in 1988. Added to inventory, in addition to those in the electrical repair kit.

Actual Inventory:

PP-GLOVES - FIREMAN

**1HM0000-LL-CQA-2201 SELECT SIZE
NSN 8415-01-421-1368 SIZE SML
NSN 8415-01-421-1371 SIZE MED
NSN 8415-01-421-1373 SIZE LRG
NSN 8415-01-421-1375 SIZE X-LRG
NSN 8415-01-421-1376 SIZE XX-LRG
(PAIR)
WT. 2.0 lbs. VOL. 108.0 in³**

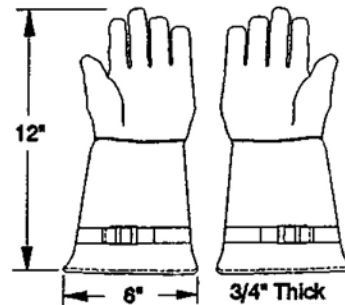

12
pair

Helpful Hints: Used for each OBA. Replace stock when worn with new firefighter's glove. Procure gloves IAW MIL-G-24934/National Fire Protection Association (NFPA) standards.

Actual Inventory:

DAMAGE CONTROL REPAIR STATION TOOLS & EQUIPMENT (3DCRS)

Quantity
Required

PP-HELMET - FIREMAN



25

NSN 8415-01-271-8069

WT. 2.9 lbs

VOL. 1,320.0 in³

Helpful Hints: Stored in helmet rack in passageway, on hook, butterfly clips or designated stowage device. Protect visor. The visor is essential for pipe patching to protect the eyes from water spray.

Actual Inventory:

**PP-HELMET - PHONE TALKER
MARK 4 MOD 0**

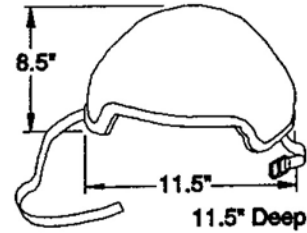

2

NSN 8470-01-127-7337

WT. 4.0 lbs.

VOL. 1,124.0 in³

Helpful Hints: Stored in phone talker helmet rack in main DCRS or passageway.

Actual Inventory:

PP-HOOD - ANTIFLASH

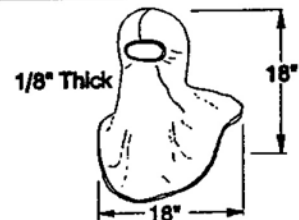

25

NSN 4210-01-493-4694

WT. 2.0 oz

VOL. 20.2 in³

Helpful Hints: Stow with life preserver and antiflash gloves. Part of G.Q. gear.

Actual Inventory:

DAMAGE CONTROL REPAIR STATION TOOLS & EQUIPMENT (3DCRS)

Quantity
Required

PP-LANTERN HEAD - (USES FOUR SIZE AA BATTERIES)

NSN 6135-00-985-7845 SIZE AA BATTERIES
NSN 6230-01-285-4396 ASSEMBLY
PHILLIPS HPR-40 OR REPLACEMENT
OSRAM 640721 HALOGEN BULB



12

WT. 1.0 lbs VOL. 117.0 in³

Helpful Hints: All kit lanterns moved to parent AEL. AA batteries supplied in package of 24. Two boxes required to outfit head lanterns.

Actual Inventory:

PP-LIFE PRESVR - Y INFLAT

NSN 4220-00-289-1891

WT. 3.0 lbs. VOL. 60.0 in³

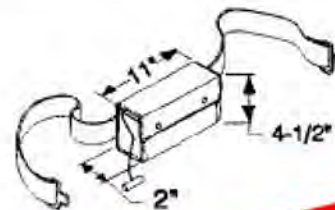

25

Helpful Hints: Should be stored with general quarters gear in passageway locker.

Actual Inventory:

PP-POWDER - TALC

NSN 8510-00-817-0295

WT. 6.0 oz VOL. 37.5 in³

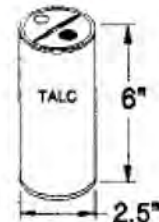

1

Helpful Hints:

Actual Inventory:

DAMAGE CONTROL REPAIR STATION TOOLS & EQUIPMENT (3DCRS)

Quantity
Required

THERMAL IMAGER -

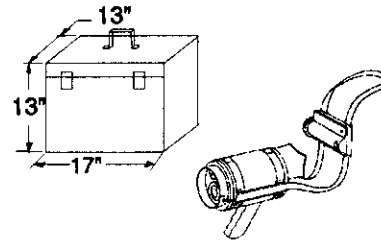

1

NSN 4210-01-213-7310

WT. 29.0 lbs. VOL. 2,873.0 in³

Helpful Hints: APL - 2930094090. Ten AA batteries are inserted into the battery cartridge to operate.

Actual Inventory:

ADAPTERS / CONNECTIONS KIT

**AEL Range: 2-880044225
2-880044224**

A limited inventory list should be provided
with this kit.

ADAPTERS / CONNECTIONS KIT

Quantity
Required

ADAPTERS / CONNECTIONS KIT

1

1HM0000-LL-CQA-2440

This kit identifies equipment for DC emergencies to provide adapters & connectors for piping systems and hose runs / jumpers. Individual items are listed on AEL #2-880044225 and in alphabetical order in this guide.

Actual Inventory:

ADAPTER - DBL (M) 4" DISCH
DESANNE MOD 74-7

1

1HM0000-LL-CQA-0770

WT. 3.0 lbs

VOL. 14.7 in.³

Helpful Hints:

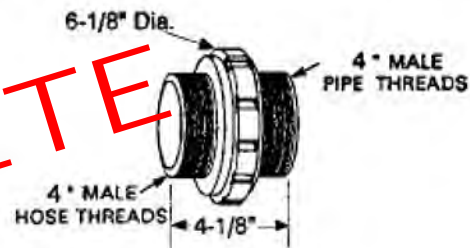

Actual Inventory:

ADAPTER - FLANGE TO HOSE THREADS
3-1/2" FLANGE / 2-1/2" (F) HOSE

1

NSN 4730-00-277-3380

WT. 9.0 lbs.

VOL. 258.3 in.³

Helpful Hints:

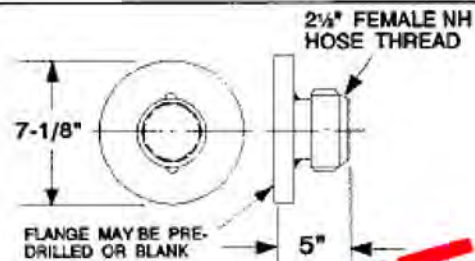

Actual Inventory:

ADAPTER - HOSE TO PIPE THREADS
1-1/2" (M) HOSE / 2-1/2" (M) PIPE

2

NSN 4210-00-277-3378

WT. 2.5 lbs.

VOL. 53.2 in.³

Helpful Hints:

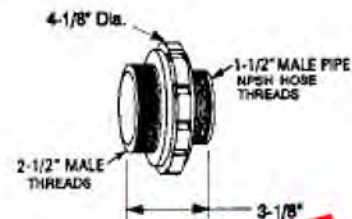

Actual Inventory:

ADAPTERS / CONNECTIONS KIT

Quantity
Required

ADAPTER - HOSE TO PIPE THREADS
1-1/2" (M) HOSE / 1" (M) PIPE

NSN 4210-00-277-3376

WT. 1.5 lbs.

VOL. 21.3 in.³

Helpful Hints:

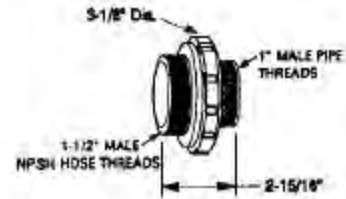

2

Actual Inventory:

ADAPTER - HOSE TO PIPE THREADS
1-1/2" (M) HOSE / 2" (M) PIPE

NSN 4210-00-277-3377

WT. 2.3 lbs.

VOL. 53.2 in.³

Helpful Hints:

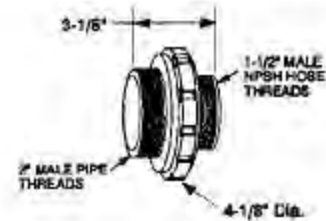

4

Actual Inventory:

ADAPTER - HOSE DBL FEM
2-1/2" (F) PIPE / 2-1/2" (F) HOSE

NSN 4210-00-355-4862

WT. 5.5 lbs.

VOL. 48.0 in.³

Helpful Hints:

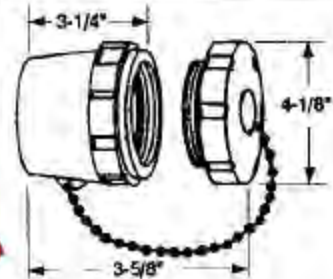

2

Actual Inventory:

ADAPTER - HOSE TO PIPE THREADS
1-1/2" (F) X 1-1/2" (M) PIPE

NSN 4210-01-037-6265

WT. 1.5 lbs

VOL. 21.3 in.³

Helpful Hints:

Lesson learned from U.S.S. Stark.
Ship's funds were required.



2

Actual Inventory:

ADAPTERS / CONNECTIONS KIT

Quantity
Required

ADAPTER - FLANGE TO HOSE THREADS
3" FLANGE / 2-1/2" (F) HOSE

NSN 4730-00-277-3379

WT. 9.5 lbs.

VOL. 296.4 in.³

Helpful Hints:

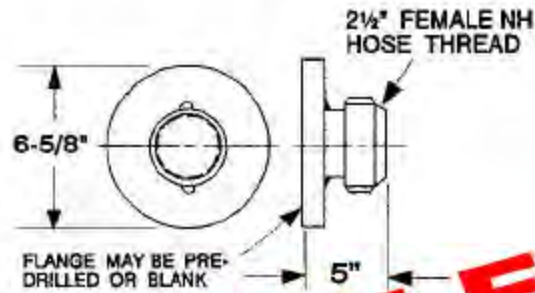

1

DELETE

Actual Inventory:

ADAPTER - FLANGE TO HOSE THREADS
3" FLANGE (M) / 2-1/2" (M) HOSE

NSN 4730-00-289-2046

WT. 7.0 lbs.

VOL. 137.0 in.³

Helpful Hints:

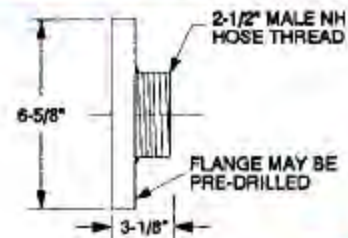

1

DELETE

Actual Inventory:

ADAPTER - FLANGE TO HOSE THREADS
3-1/2" FLANGE / 2-1/2" (M) HOSE

NSN 4730-00-289-2047

WT. 7.0 lbs.

VOL. 187.7 in.³

Helpful Hints:

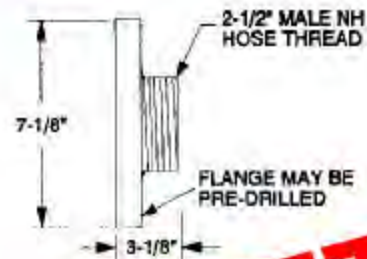

1

DELETE

Actual Inventory:

ADAPTERS / CONNECTIONS KIT

Quantity
Required

ADAPTER - FLANGE TO HOSE THREAD
4" FLANGE / 2-1/2" (F) HOSE

NSN 4730-00-277-3381

WT. 10.0 lbs.

VOL. 294.9 in.³

Helpful Hints:

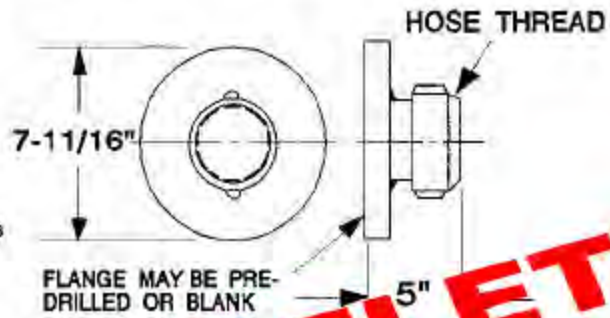

1

DELETE

Actual Inventory:

ADAPTER - FLANGE TO HOSE THREAD
4" FLANGE / 2-1/2" (M) HOSE

NSN 4730-00-289-2048

WT. 9.0 lbs.

VOL. 187.7 in.³

Helpful Hints:

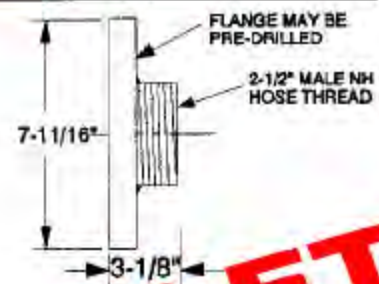

1

DELETE

Actual Inventory:

ADAPTER - FLANGE TO HOSE THREAD
5" FLANGE / 2-1/2" (F) HOSE

NSN 4730-00-277-3382

WT. 13.0 lbs.

VOL. 232.9 in.³

Helpful Hints:

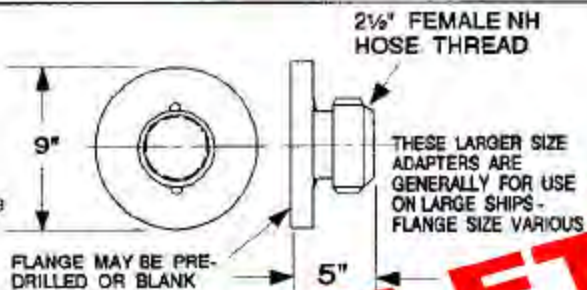

1

DELETE

Actual Inventory:

ADAPTERS / CONNECTIONS KIT

Quantity
Required

ADAPTER - FLANGE TO HOSE THREADS
5" FLANGE / 2-1/2" (M) HOSE

NSN 4730-00-289-2049

WT. 12.0 lbs.

VOL. 187.7 in.³

Helpful Hints:

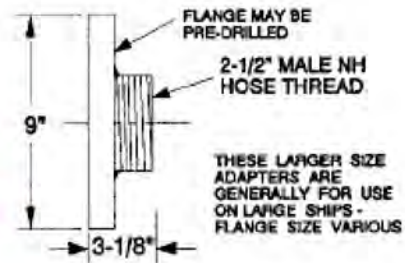

1

Actual Inventory:

ADAPTER - FLANGE TO HOSE THREADS
6" FLANGE / 2-1/2" (F) HOSE

NSN 4730-00-277-3383

WT. 15.0 lbs.

VOL. 194.6 in.³

Helpful Hints:

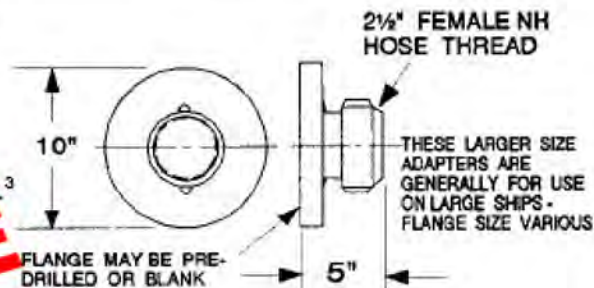

1

Actual Inventory:

ADAPTER - FLANGE TO HOSE THREADS
6" FLANGE / 2-1/2" (M) HOSE

NSN 4730-00-289-2050

WT. 17.0 lbs.

VOL. 281.9 in.³

Helpful Hints:

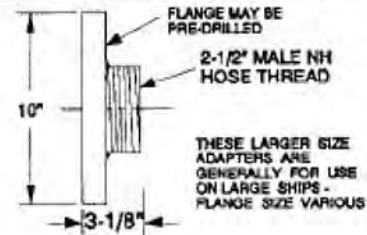

1

Actual Inventory:

BAG-TOOL SATCHEL

NSN 5140-00-293-2379

WT. 3.9 lbs

VOL. 11,248.0 in.³

Helpful Hints:

Utilize current onboard stowage device to hold adapters. Can be bag or tool box with approximate dimensions (not to exceed 18" in dia./width/height).



Actual Inventory:

ADAPTERS / CONNECTIONS KIT

Quantity
Required

CONNECTION - HOSE
DOUBLE MALE 1-1/2"
WITH ROCKER LUGS

NSN 4210-00-277-3374

WT. 0.5 lbs.

VOL. 21.3 in.³

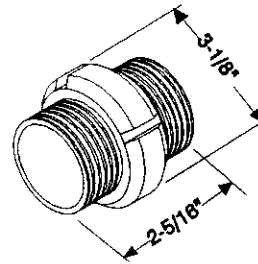

2

Helpful Hints:

Actual Inventory:

CONNECTION - WYE GATE
2-1/2" INLET x TWO 1-1/2" OUTLETS

NSN 4210-00-255-0234

WT. 11.0 lbs.

VOL. 185.9 in.³

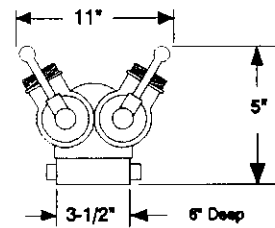

2

Helpful Hints:

Actual Inventory:

COUPLING HOSE - HOSE 2-1/2"
DOUBLE FEMALE, BOTH ENDS IDENTICAL
WITH SWIVELS, ROCKER AND GASKET SEALS.

NSN 4210-00-288-8816

WT. 4.0 lbs.

VOL. 53.2 in.³

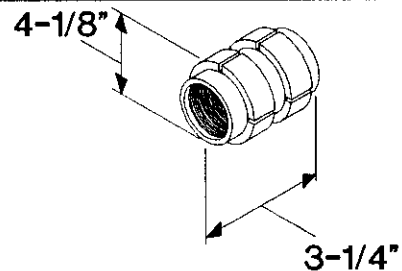

2

Helpful Hints:

Actual Inventory:

ADAPTERS / CONNECTIONS KIT

Quantity
Required

COUPLING HOSE - HOSE 1-1/2"
DOUBLE FEMALE, BOTH ENDS IDENTICAL
WITH SWIVELS, ROCKER AND GASKET SEALS.

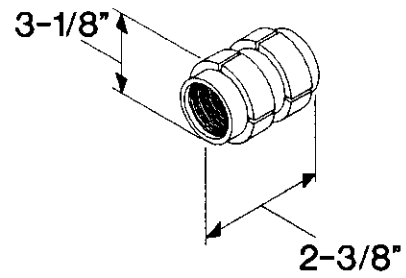

2

NSN 4210-00-307-4699

WT. 2.5 lbs.

VOL. 18.2 in.³

Helpful Hints:

Actual Inventory:

REDUCER - HOSE
2-1/2" (F) TO 1-1/2" (M)
WITH ROCKER LUGS

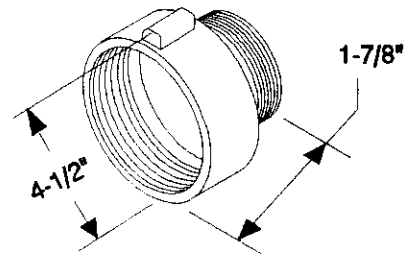

2

NSN 4210-00-202-7466

WT. 3.0 lbs.

VOL. 38.0 in.³

Helpful Hints:

Actual Inventory:

REDUCER - HOSE
4" (M) TO 3" (F)
USE WITH P-250/EDUCTOR

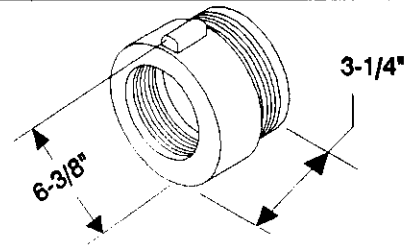

2

NSN 4730-00-618-8593

WT. 11.0 lbs.

VOL. 132.1 in.³

Helpful Hints:

Actual Inventory:

BANDING TOOL KIT

**AEL Range: 2-880044226
2-880044223**

A limited inventory list should be provided
with this kit.

BANDING TOOL KIT

Quantity
Required

KIT - BANDING KIT - BANDING TOOL-DC

1H 0000-LL-CQA-2441

This kit identifies all equipment used for the function of providing emergency pipe patching material, as well as emergency securing devices for other components. Individual items are listed on AELs #2-880044226 (1 to 8 kits) and #2-88004223 (7 to 72 kits) and in alphabetical order in this guide.

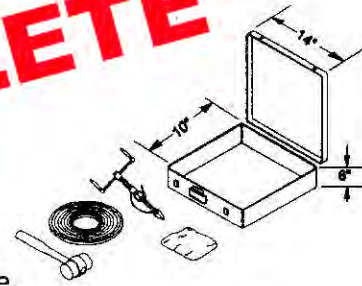

1 Kit

Helpful Hints: Current requirement - stow items together as kit in DCRS. Requirement is for two 100 foot rolls of 1/2" steel strapping and one box containing (100) 1/2" seals (buckles) for steel strapping, clamping tool and a ball peen hammer.

Actual Inventory:

BANDING KIT - CLAMPING TOOL - STRAP
BAND-IT KIT.

NSN 5120-00-278-992F

WT. 3.0 lbs.

VOL. 159.7 in.³

DELETE

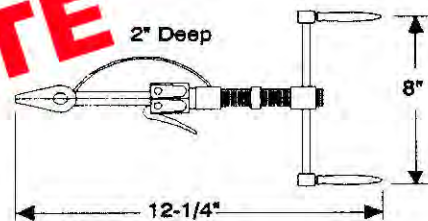

1

Helpful Hints:

Actual Inventory:

BANDING KIT - SEAL - STEEL STRAPPING
BAND-IT BUCKLE

NSN 5340-00-244-7325 1/2" ST
(BOX OF 100 - 7" x 9" x 2")

WT. VARIOUS

VOL. VARIOUS

DELETE

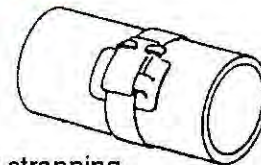

1
box

Helpful Hints: Each box contains 100 each 1/2" seals (buckles) for steel strapping.

Actual Inventory:

BANDING TOOL KIT

Quantity
Required

**BANDING KIT - STEEL STRAPPING - FLT
USED WITH BAND-IT BUCKLE**

NSN 5340-00-245-9438 1/2"

WT. 9.0 lbs (Avg)

VOL. 42.0 in³

DELETE

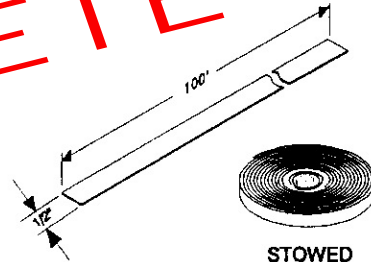

2
rolls

Helpful Hints: Use a 1.5 lb. ball peen hammer to peen down rabbit ears on buckles when installing bands and buckles. Stow strapping in strapping container - 1HM0099-LL-H82-4841 when available or in original shipping container.

Actual Inventory:

CONTAINER - STRAPPING

1HM0099-LL-H82-4841

WT. 1.5 lbs

VOL. 121.0 in³

DELETE

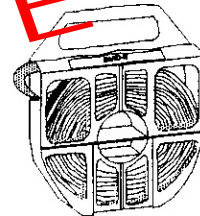

1

Helpful Hints: Used to stow steel strapping. Cut hole in case to insert bitter end of strapping for safety. NAVSEA will outfit as funds are available.

Actual Inventory:

GLOVES - CUT RESISTANT

1HS0000-LL-CQA-4568

NSN 4220-01-397-7348 - sz med

4220-01-397-7349 - sz lg

WT. 0.5 lbs.

VOL. 56.0 in.³

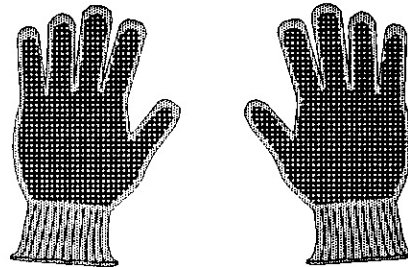

2 pr
ea
size

Helpful Hints: Always wear gloves - cut resistant type, eye protection and long sleeves for personnel safety when working during banding operations. NAVSEA will outfit as funds are available.

Actual Inventory:

BANDING TOOL KIT

Quantity
Required

HAMMER - MCHST
1-1/2 LB.
15" HANDLE, HICKORY

NSN 5120-00-061-8545

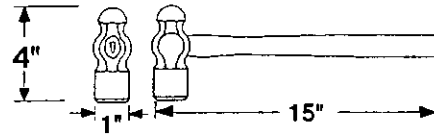

1

WT. 2.0 lbs. VOL. 60.0 in.³

Helpful Hints: Ball peen hammer used to knock down ears on buckle to secure strapping.

Actual Inventory:

STRONGBACK - FOR 2", 3" AND 4" PIPE

NSN 4710-00-468-8857 - 2" pipe
NSN 4710-00-468-8858 - 3" pipe
NSN 4710-00-468-8859 - 4" pipe

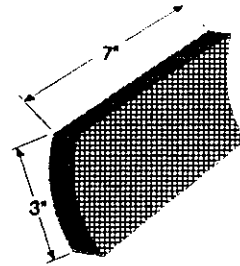

2

WT. 1.0 lbs. VOL. 28.0 in.³

Helpful Hints: All strongbacks are 3" x 7". Glue 1/8" rubber gasket to backside of strongback for ready use. Provide two of each size. NAVSEA will outfit as funds are available.

Actual Inventory:

WRENCH - CHAIN TYPE

NSN 5120-00-889-2050

WT. 3.0 lbs VOL. 162.0 in.³

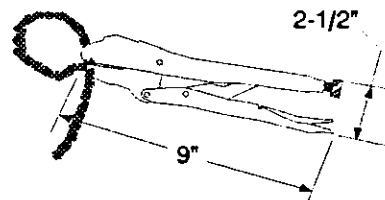

3

Helpful Hints: 9" Long with 18" chain. Dry wrench after use. Keep lubricated and wrapped with a rag, to prevent rusting. NAVSEA will outfit as funds are available.

Actual Inventory:

**DELETE
This Kit**

CBR EQUIPMENT KIT

AEL Range: 2-880044227 to 4228

A laminated inventory list should be provided with this kit.

CBR EQUIPMENT KIT

Quantity
Required

KIT - CBR EQUIPMENT

1HM0000-LL-CQA-2442

This kit identifies equipment to be used while conducting personnel monitoring and ship's chemical, biological and radiological surveys. Individual items are listed on AEL #2-880044227 and in alphabetical order in this guide. For DCRS radiacs, dosimeters, and personnel dosimeter readers allowance, draw from total ships quantity. See radiac policies and procedures manual SE700-AA-MAN-410/Radiac, Vol 4 Part 1, Radiac Equipment Allowance for Ships; For DCRS allowance for DCRS radiac standard calibration intervals, see Radiac Policies and Procedures Manual SE700-AA-MAN-210/Radiac, Vol 2 Part 1, Radiac Calibration Program Allowances for Summary of Calibration Intervals. Allowance requirements for individual ship classes are listed in AELs 2-770004241 and 4251.

DELETE

COMPUTER - INDICATOR
CP-95/PD

NSN 6665-00-526-8645

WT. 20.0 lbs

VOL. 1420.0 in³

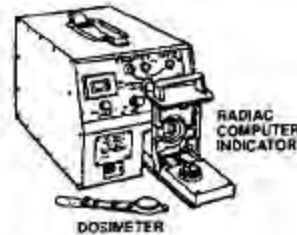

AR

Helpful Hints: DT-60 reader, used at personnel decontamination stations to read accumulated dosage to gamma radiation. This is a calibration item.

Actual Inventory:

CP-KIT - M256A1 CHEM DETECTOR

NSN 6665-01-133-4964

WT. 1.2 lbs

VOL. 105.0 in³



10

Helpful Hints: Kit consists of 12 individually packaged samplers detectors and instruction cards.

Actual Inventory:

CBR EQUIPMENT KIT

Quantity
Required

KIT - M256A1 - TRAINING KIT

NSN 6665-01-112-1644

WT. 1.2 lbs VOL. 105.0 in³

DELETE



Helpful Hints: Two per DCRS on CV and CVN class ships; and one per DCRS for all other surface ships.

Actual Inventory:

DOSIMETER CHARGER -
PP-4276 C/PD

NSN 6665-00-489-3106

WT. 13.5 oz VOL. 56.0 in³

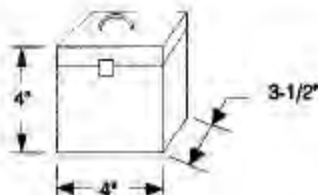

AR

Helpful Hints: Charges the IM 143 PD.

DELETE

Actual Inventory:

CBR EQUIPMENT KIT

Quantity
Required

DOSIMETER HIGH RANGE - IM-1433/PD

NSN 6665-00-764-6395

WT. 2.0 oz VOL. 4.0 in³

Helpful Hints: The dosimeter charger PP-4276 C/PD is used to charge the IM-143/PD.

DELETE



AR

Actual Inventory:

M8 PAPER - CHEMICAL AGENT
DETECTOR

NSN 6665-00-050-8529

WT. 7.0 oz VOL. 2.0 in³

Helpful Hints: Detects liquid nerve/blister agents.

DELETE



10
per
DCRS

Actual Inventory:

M9 PAPER - CHEMICAL AGENT
DETECTOR

NSN 6665-01-226-5589

(WITH DISPENSER)

WT. 7.0 oz VOL. 28.4 in³

Helpful Hints: One roll for training and two rolls for contingency. Stow in DCRS. Two rolls are stowed in CBR storeroom for each DCRS.

DELETE

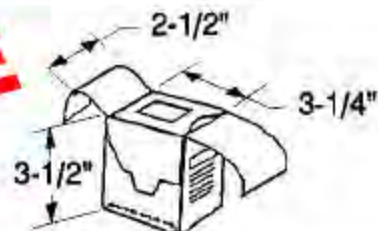

3

Actual Inventory:

CBR EQUIPMENT KIT

Quantity
Required

RADIAC SET - AN/PDR 27

NSN 6665-01-080-4418

WT. 11.0 lbs VOL. 1,152.0 in³

Helpful Hints: Low range meter. This is a calibration item.

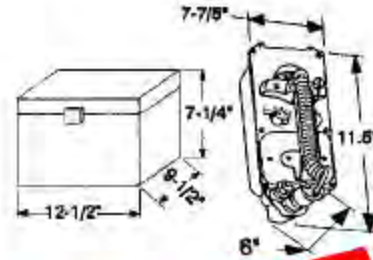

AR

DELETE
Actual Inventory:

RADIAC SET - AN/PDR 43

NSN 6665-01-116-7260

WT. 7.2 lbs VOL. 289.4 in³

Helpful Hints: High range meter. This is a calibration item.

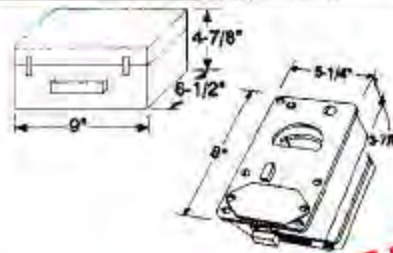

AR

DELETE
Actual Inventory:

**DELETE
This Kit**

CBR PERSONNEL KIT

AEL Range: 2-880044229 to 4231

CBR PERSONNEL KIT

Quantity
Required

KIT - CBR PERSONNEL-DC

1H 0000-LL-CQA-2443

This kit identifies all equipment used in the function of providing personnel protection and decontamination materials in a CBR environment. Individual items are listed on AEL #2-880044243 thru 4250 and in alphabetical order in this guide.

25
Kits

Helpful Hints: Draw from ship's total allowance for Damage Control Repair Party usage. Twenty percent of total ship allowance is used to conduct training.

Actual Inventory:

ATROPINE - INJECTION

NSN 6505-00-926-9083

WT. 0.3 lbs

VOL. 15.0 in³



As
Reqd

Helpful Hints: This is a BUMED control item. Listed for information and stowed as directed by the Medical Department.

Actual Inventory:

BAG-KIT -

NSN 8460-00-606-8366

WT. 2.3 lbs

VOL. 5,804.5 in³



As
Reqd

Helpful Hints:

Recommended to protect CBR personnel gear. If bag is used, must fit through 18" escape scuttle. DO NOT OVERPACK BAG.

Actual Inventory:

CBR PERSONNEL KIT

Quantity
Required

BELT-WEBB -

NSN 8465-01-322-1966 - for waists 30" and above.
8465-01-322-1965 - for waists under 30"

WT. 0.5 lbs VOL. 20.0 in³

DELETE



As
Reqd

Helpful Hints: Webb belt is used with the water canteen. Recommended tariff, or percentage of ships total allowance for the two webb belt sizes is 16% medium and 84% large.

Actual Inventory:

CANTEEN, WATER - 1 QT

NSN 8465-01-115-0026 - CANTEEN
8465-00-930-2077 - COVER

WT. 0.5 lbs VOL. 52.5 in³

DELETE



Helpful Hints: Allowance of canteen sets will be 105% of SMD. The canteen set consists of a one quart canteen, a canteen cover and a webb belt.

Actual Inventory:

CP-CANISTER - MCU 2A/P (C-2) GREEN

NSN 4240-01-119-2315
(CAN OF 2)

WT. 0.8 lbs. VOL. 34.7 in³

DELETE



25

Helpful Hints: Can be stowed in DCRS, CBR lockers, or CBR storeroom. Allowance for each CP mask is three, which includes one for training. Two canisters are provided with each mask and the third must be requisitioned separately.

Actual Inventory:

CBR PERSONNEL KIT

Quantity
Required

CP-FOOTWEAR COVERS - CHEMICAL PROTECTION

NSN 8430-01-021-5978 SIZE LRG

BOX OF 20
WT. 54.0 lbs.

VOL. 6480.0 in³



25

DELETE

Helpful Hints: Can be stowed in DCRS, CBR lockers or CBR storeroom.

Actual Inventory:

CP-GLOVES - CBR PROTECTIVE 25 MIL THICKNESS

1H 0000-LL-CQA-2499 (SELECT SIZE)

NSN 8415-01-033-3517 SIZE SML

NSN 8415-01-033-3518 SIZE MED

NSN 8415-01-033-3519 SIZE LRG

NSN 8415-01-033-3520 SIZE X-LRG

BOX OF 72

WT. 36.0 lbs
(0.5 lb pr)

VOL. 5316.5 in³
(74.3 in³ pr)

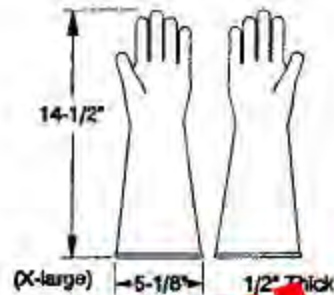

AR

DELETE

Helpful Hints: Can be stowed in DCRS, CBR lockers or CBR storeroom.

Actual Inventory:

CP-GLOVE SET INSERT - COTTON

NSN 8514-01-138-2494 - SMALL

8514-01-138-2495 - MEDIUM

8514-01-138-2496 - LARGE

WT. 1.5 oz

VOL. 32.0 in³

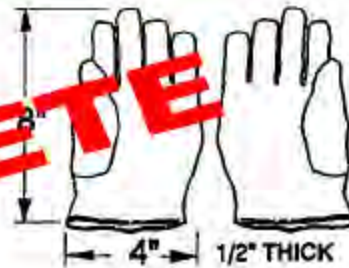

AR

DELETE

Helpful Hints: Cotton inserts. Inserted in type II chemical protective gloves during CBR training and emergency evolutions.

Actual Inventory:

CBR PERSONNEL KIT

Quantity
Required

CP-KIT - M291
SKIN DECON

NSN 4230-01-276-1905

WT. 3.2 oz

VOL. 19.2 in³

DELETE



see
HH

Helpful Hints: Stored with MCU-2/P mask. Stowed in DCRS, CBR locker or CBR storeroom. Allowance is 138% SMD or 1 box of 20 kits per 14%. Includes 33% SMD or 1 skin decon kit per 3 personnel for annual training.

Actual Inventory:

CP-MASK - MCU 2A/P

1HS0000-LL-CQA-3202
NSN 4240-01-327-4148
NSN 4240-01-327-4149
NSN 4240-01-327-4150

(SELECT SIZE)
SIZE SML
SIZE MED
SIZE LRG

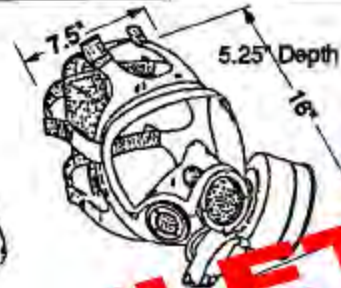
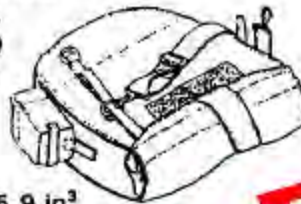

25

WT. 6.4 lbs

VOL. 575.9 in³

DELETE

Helpful Hints: There are two current models. These are the MCU-2/P and the MCU-2A/P. The shipboard tariff for the CP-Mask, MCU series is 17% small, 62% medium and 21% large.

Actual Inventory:

CP-OVERGARMENT

1H 0000-LL-CQA-2504 (SELECT SIZE)
NSN 8415-01-214-8289 SIZE SML
NSN 8415-01-214-8290 SIZE MED
NSN 8415-01-214-8291 SIZE LRG
NSN 8415-01-214-8292 SIZE X-LRG
(BOX)

WT. 3.3 lbs.

VOL. 305.3 in³ (STOWED 6" X 11" X 4-5/8")

DELETE



Helpful Hints: Can be stowed in DCRS, CBR lockers or CBR storeroom.

Actual Inventory:

CBR PERSONNEL KIT

Quantity
Required

DETECTOR - RADIAC
DT-60
CASUALTY PERSONNEL DOSIMETER
RANGE 25R TO 600R OR 10R TO 600R
DEPENDING ON MODEL

NSN 6665-00-526-7836
(BOX OF 30)
WT. 1.9 lbs.

VOL. 179.2 in³

Helpful Hints: DCRS qty _____

DELETE

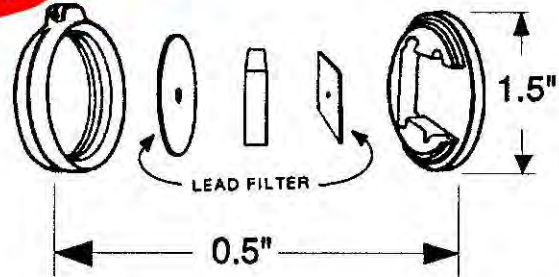

25
CBR
Strm

Actual Inventory:

SPECTACLES - COMBAT
FOR MCU 2/P OR OBA MASK

6540-01-107-0304
6540-01-107-0305
6540-01-294-1142
6540-01-109-5040

SIZE 44-46
SIZE 48-50
SPARE BRIDLES
SPARE STRAPS

WT. 1.0 oz

VOL. 2.1 in³

DELETE



As
Reqd

Actual Inventory:

Helpful Hints: As required for individuals requiring glasses. Available through the ship's Medical Dept. Required quantities of field repair parts shall be 2% SMD and maintained by the ship's Medical Dept.

**COLLECTIVE
PROTECTIVE SYSTEM
(CPS)
REPAIR KIT**

AEL Range: 2-880044235

A limited inventory list should be provided
with this kit.

CPS REPAIR KIT

Quantity
Required

KIT - COLLECTIVE PROTECTION SYS

This kit identifies all equipment used for the function of providing temporary CPS integrity. Individual items are listed on AEL #2-880044235 and in alphabetical order in this guide

BAG-KIT -

NSN 8460-00-606-6366

WT. 2.3 lbs

VOL. 5,804.5 in³

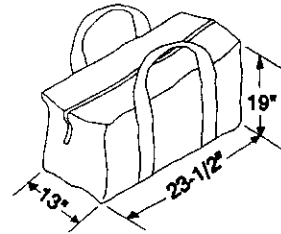

As
Reqd

Helpful Hints:

Recommended to protect CBR personnel gear. If bag is used, must fit through 18" escape scuttle. DO NOT OVERPACK BAG.

Actual Inventory:

PLASTIC SHEET - ROLLED 30" WIDE - 9" SPOOL

NSN 8135-00-579-6487

WT. 70.0 lbs

VOL. 1,908.5 in³

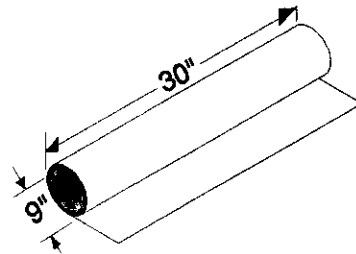

1
roll

Helpful Hints:

Actual Inventory:

SEALING COMPOUND - DUCT SEALER

NSN 8030-00-281-2337

WT. 5.0 lbs

VOL. 24.0 in³

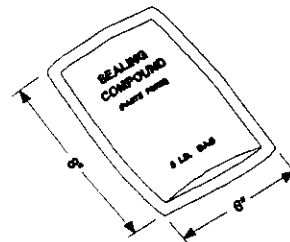

1
bag

Actual Inventory:

CPS REPAIR KIT

Quantity
Required

SHEET - RUBBER SOLID
1/8" X 36" WIDE ROLL - 10 FT LONG

NSN 5330-00-244-0192

WT. 3.0 lbs. **VOL.** 576.0 in³

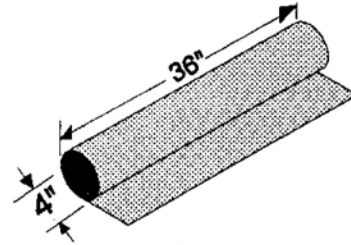

10
ft

Actual Inventory:

TAPE - DUCT
2" WIDE ROLL - 6" DIA

NSN 5640-00-103-2254

WT. 1.8 lbs **VOL.** 72.0 in³

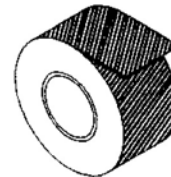

1
roll

Actual Inventory:

SCISSORS - BANDAGE

NSN 6515-00-935-7138

1

**DAMAGE CONTROL
PETTY OFFICER
(DCPO)
TOOL KIT**

AEL Range: 2-880044236

Supports the shipboard DCPO program.
Not part of DCRS inventory. A laminated
inventory list should be provided with this
kit.

DCPO KIT

Quantity
Required

KIT - DAMAGE CONTROL
PETTY OFFICER (DCPO) TOOL-DC

1H 0000-LL-CQA-2445

This kit identifies all equipment used for the function of performing DC maintenance in accordance with MRC PMS requirements for divisional damage control. Individual items are listed on AEL #2-880044236 and in alphabetical order in this guide. This is for information to assist the DCPO program. NAVSEA funds are not required.

AURAL PROTECTOR, HEADSET -

NSN 4240-00-759-3290

WT. 0.6 lbs VOL. 108.0 in³



1

Helpful Hints:

Actual Inventory:

BRUSH - PAINT

NSN 8020-00-721-9650

WT. 0.3 lbs. VOL. 6.0 in³

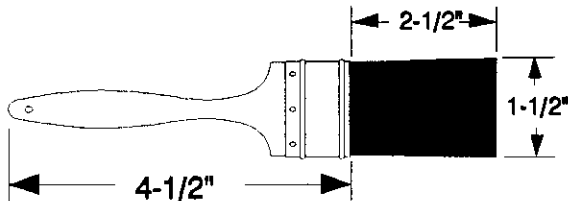

1

Helpful Hints:

Actual Inventory:

DCPO KIT

Quantity
Required

BRUSH - WIRE

NSN 7920-00-291-5815

WT. 1.0 lbs VOL. 26.0 in³

Helpful Hints:

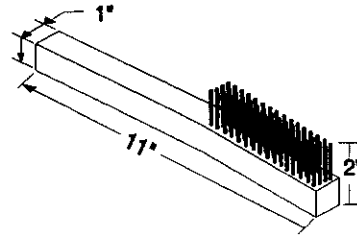

1

Actual Inventory:

CHALK - MARKING

NSN 7510-00-282-6924 ASSORTMENT
(BOX)

WT. 8.0 oz VOL. 28.0 in³

Helpful Hints:

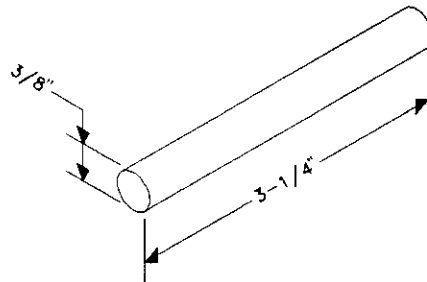

1

Actual Inventory:

COTTER PIN - ASSORTMENT

NSN 5315-00-598-5916

WT. VARIOUS VOL. VARIOUS

Helpful Hints:

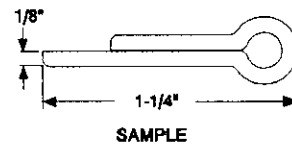

1

Actual Inventory:

ERASER - RUBBER

NSN 7510-00-223-7046

WT. 1.0 oz VOL. 0.4 in³

Helpful Hints:

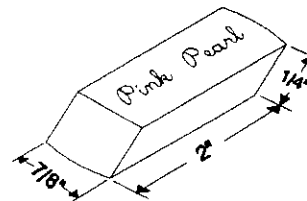

1

Actual Inventory:

DCPO KIT

Quantity
Required

FILE SET - NDL 2

NSN 5110-00-204-2685

WT. 2.4 lbs VOL. 20.0 in³

Helpful Hints:

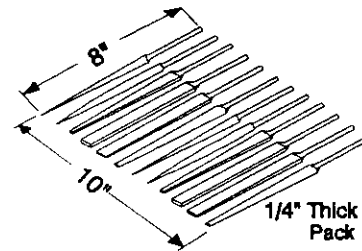

1

Actual Inventory:

FILE - HAND FLT
SMITH 6-1/4"

NSN 5110-00-234-6532

WT. 3.0 oz VOL. 0.5 in³

Helpful Hints:

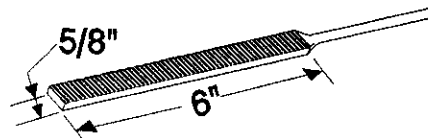

1

Actual Inventory:

FINGER - MECHANICAL

NSN 5120-00-629-6258

WT. 3.0 oz VOL. 2.8 in³

Helpful Hints:

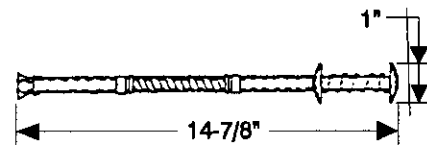

1

Actual Inventory:

FLASHLIGHT - WATERPROOF

NSN 6230-00-270-5418

WT. 3.0 oz VOL. 43.1 in³

Helpful Hints:

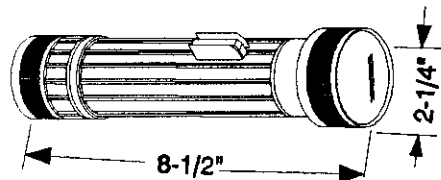

1

Actual Inventory:

Without "D" cell batteries, with 2 lamps (1 spot and 1 diffusing), 2 Filters, 1 blackout and 1 red lens.

DCPO KIT

Quantity
Required

GLOVES - CLOTH

NSN 8415-00-268-8330
(PAIR)

WT. 1.5 oz **VOL. 32.0 in³**

Helpful Hints:

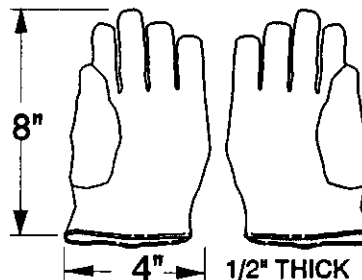

1

Actual Inventory:

GLOVES - TOXICOLOGICAL PROT 14" LENGTH

NSN 8415-00-753-6552 SIZE MED
NSN 8415-00-753-6553 SIZE LRG
NSN 8415-00-753-6554 SIZE X-LRG
(PAIR)

WT. 1.0 lbs **VOL. 77.0 in³**

Helpful Hints:

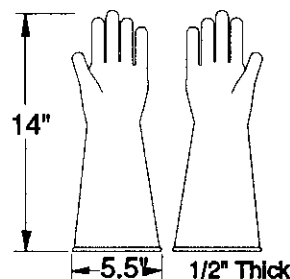

Set

Actual Inventory:

GOGGLES - INDUSTRIAL

NSN 4240-00-764-5152

WT. 0.4 lbs. **VOL. 24.0 in³**

Helpful Hints:

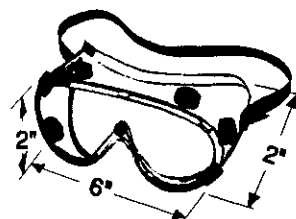

1

Actual Inventory:

DCPO KIT

Quantity
Required

**GUN - GRE-PSTL GRIP
WITH 12" GREASE HOSE
14 OZ. CARTRIDGE
NSN 4930-00-965-0288**

WT. 3.0 lbs. VOL. 50.0 in³

Helpful Hints:

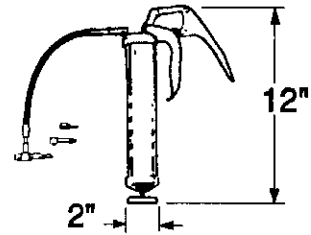

1

Actual Inventory:

**HAMMER - BALLPEEN
MACHINIST 1-1/2 LB.
15" HANDLE (HICKORY)**

NSN 5120-00-061-8545

WT. 2.0 lbs. VOL. 60.0 in³

Helpful Hints:

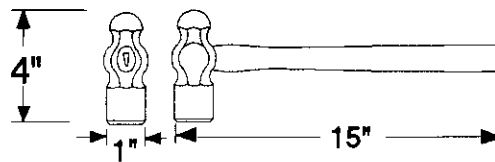

1

Actual Inventory:

KEY SET -

NSN 5120-00-595-9244

WT. 5.0 lbs. VOL. 22.5 in³

Helpful Hints:

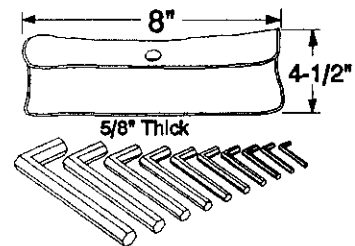

1

Actual Inventory:

**KNIFE - PUTTY 1-1/4"
SEMI-FLEXIBLE**

NSN 5120-00-294-4605

WT. 2.0 oz VOL. 8.8 in³

Helpful Hints:

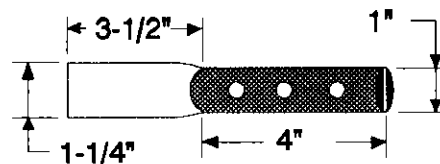

1

Actual Inventory:

DCPO KIT

Quantity
Required

MIRROR - INSP 2-1/4" DIA

NSN 5120-01-278-8257

WT. 3.0 oz VOL. 2.2 in³

Helpful Hints:

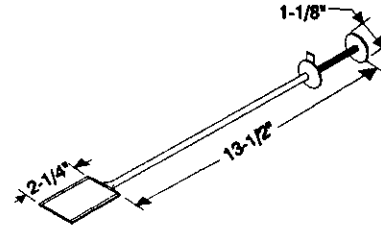

1

Actual Inventory:

OILER - HND 1 PT FLEX SPO

NSN 4930-00-262-8868

WT. 1.0 lbs. VOL. 34.8 in³

Helpful Hints:

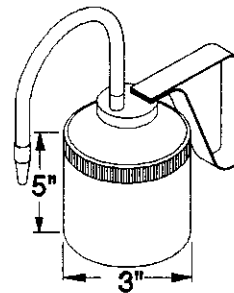

1

Actual Inventory:

**PLIERS - SJ COMB 6", STRAIGHT NOSE
COMBINATION JAW WITH WIRE CUTTER**

NSN 5120-00-223-7396

WT. 6.0 oz VOL. 5.6 in³

Helpful Hints:

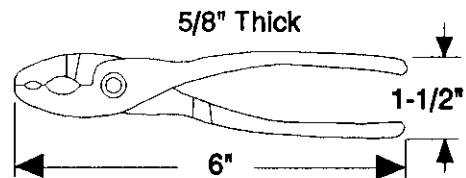

1

Actual Inventory:

**PLIERS - SJ 8", STRAIGHT NOSE
COMBINATION JAW WITH WIRE CUTTER**

NSN 5120-00-240-6217

WT. 8.0 oz VOL. 10.5 in³

Helpful Hints:

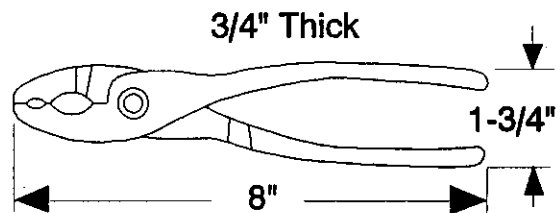

1

Actual Inventory:

DCPO KIT

Quantity
Required

PUNCH-DRIFT - 3/8"

NSN 5120-00-242-0764

WT. 0.3 lbs. VOL. 0.4 in³

Helpful Hints:

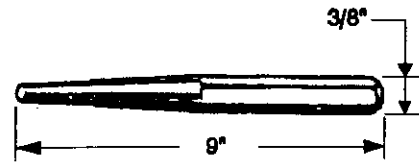

1

Actual Inventory:

RAGS - COTTON

**NSN 7920-00-205-1711
(BALE)**

WT. 50.0 lbs. VOL. 13,824.0 in³

Helpful Hints: Rags are to be stowed in the work center.

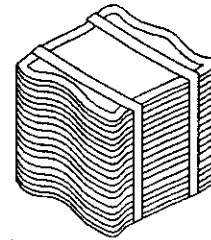

1

Actual Inventory:

**RULE - STEEL MACHINIST
6 FOOT LONG**

NSN 5210-00-971-8827

WT. 0.4 lbs. VOL. 3.4 in³

Helpful Hints:

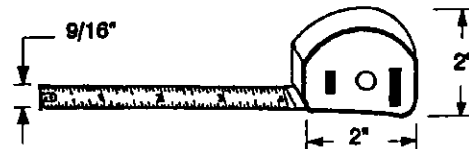

1

Actual Inventory:

SCRAPER - SHIP CRBN STL

NSN 5110-00-240-3094

WT. 0.5 lbs. VOL. 3.3 in³

Helpful Hints:

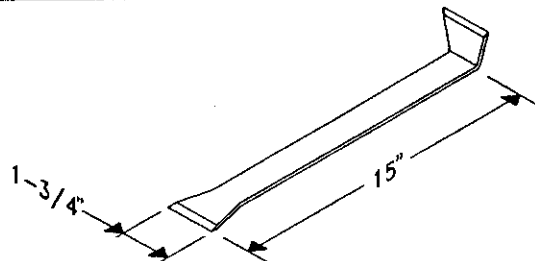

1

Actual Inventory:

DCPO KIT

Quantity
Required

SCREWDRIVER - CRS TIP SZ2
#2 BLADE TIP

NSN 5120-00-234-8913

WT. 0.3 lbs VOL. 6.4 in³

Helpful Hints:

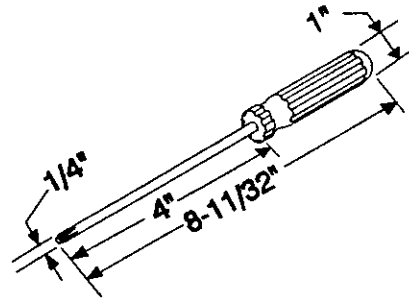

2

Actual Inventory:

SCREWDRIVER - CRS TIP 8"
#4 BLADE TIP

NSN 5120-00-542-3438

WT. 0.6 lbs VOL. 10.2 in³

Helpful Hints:

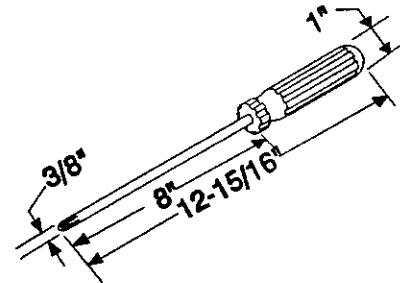

1

Actual Inventory:

SCREWDRIVER - FLAT TIP
3/8" x 10"

NSN 5120-00-293-3309

WT. 0.8 lbs VOL. 13.7 in³

Helpful Hints:

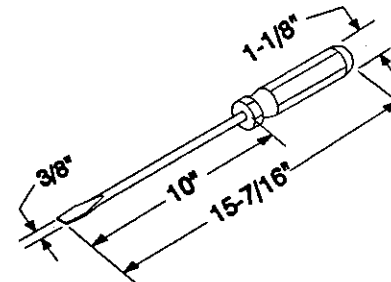

Actual Inventory:

DCPO KIT

Quantity
Required

SCREWDRIVER - FLAT TIP
5/16" x 8"

NSN 5120-00-234-8910

WT. 0.6 lbs **VOL.** 10.2 in

Helpful Hints:

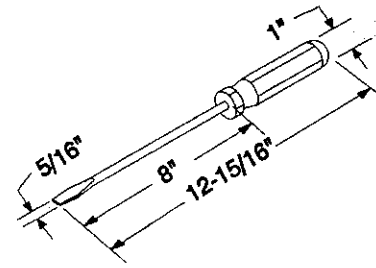

1

Actual Inventory:

SCREWDRIVER - FLAT TIP
5/16" x 6"

NSN 5120-00-278-1283

WT. 0.5 lbs **VOL.** 8.6 in³

Helpful Hints:

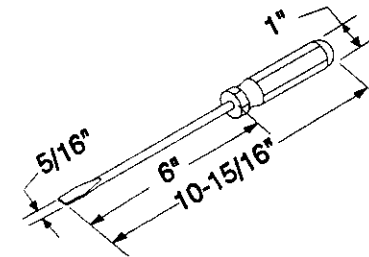

1

Actual Inventory:

SCRIBER - MCHST SMALL PNT

NSN 5120-00-224-9728

WT. 0.1 lbs **VOL.** 0.8 in³

Helpful Hints:

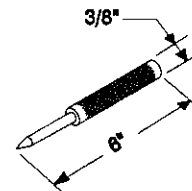

5

Actual Inventory:

SILICONE COMPOUND -
5 OZ TUBE

NSN 6850-00-880-7616

WT. 5.0 oz **VOL.** 4.7 in³

Helpful Hints:

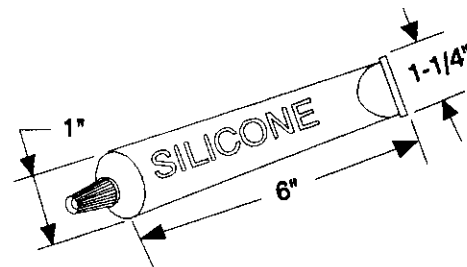

1

Actual Inventory:

DCPO KIT

Quantity
Required

STENCIL SET - 1 IM

NSN 7520-00-298-7043

WT. 2.0 lbs. **VOL.** 60.0 in³

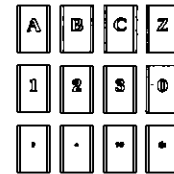

1

Helpful Hints:

Actual Inventory:

TAPE - PRESSURE SENSITIVE
3/4" WIDE ROLL - 6" DIA

NSN 7510-00-987-6661

WT. 0.5 lbs **VOL.** 27.0 in³

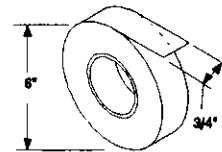

1

CLEAR POLYESTER-FILM
72 Yard Long, 3/4" Wide

Helpful Hints:

Actual Inventory:

TOOL BOX - STL SFTR

NSN 5140-00-587-5558

WT. 6.8 lbs **VOL.** 1,036.0 in³

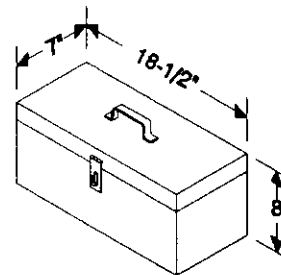

1

Helpful Hints:

Actual Inventory:

DCPO KIT

Quantity
Required

WRENCH - PLIERS 8-1/2"
(VICE GRIP)
1-3/4" JAW OPENING
TWO CURVED JAWS

NSN 5120-00-494-1911

WT. 1.0 lbs VOL. 10.6 in³

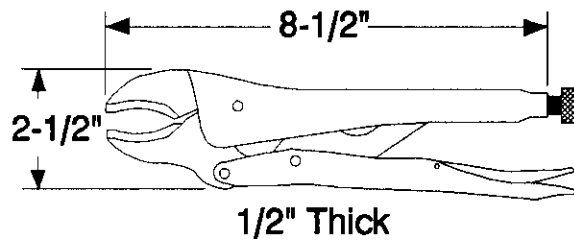

1

Helpful Hints:

Actual Inventory:

WRENCH - MONKEY
(ADJUSTABLE AUTO)
11" LONG, ADJUSTABLE TO 2-3/4"
OPENING
STEEL

NSN 5120-00-473-6476

WT. 2.5 lbs. VOL. 41.2 in.³

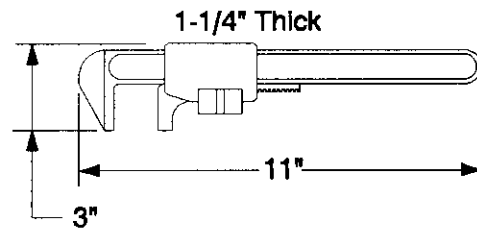

1

Helpful Hints:

Actual Inventory:

WRENCH SET - 5/16" TO 1" COMBINATION
12 PC SET

NSN 5120-00-148-7917

WT. 5.7 lbs VOL. 50.6 in³

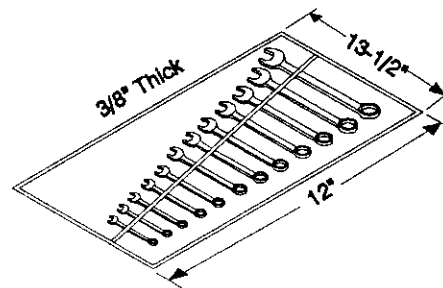

1

Helpful Hints:

Actual Inventory:

DCPO KIT

Quantity
Required

**WRENCH SET - SOCKET 1/2" DRIVE
20 PC SET**

NSN 5120-00-081-2307

WT. 20.0 lbs VOL. 733.0 in³

Helpful Hints:

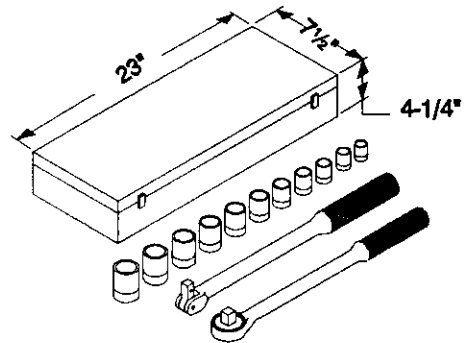

1

Actual Inventory:

**WRENCH - CRESCENT
10" LONG**

NSN 5120-00-449-8083

WT. 1.5 lbs VOL. 15.0 in³

Helpful Hints:

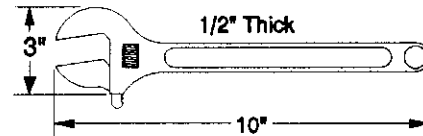

1

Actual Inventory:

**WRENCH - CRESCENT
12" LONG
STEEL**

NSN 5120-00-264-3796

WT. 2.0 lbs. VOL. 29.9 in.³

Helpful Hints:

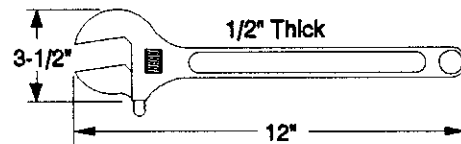

2

Actual Inventory:

DCPO KIT

Quantity
Required

WRENCH - PLIERS 7"
(VICE GRIP)
1-1/2" JAW OPENING
TWO CURVED JAWS

NSN 5120-00-494-1910

WT. 0.6 LBS VOL. 8.71 in³

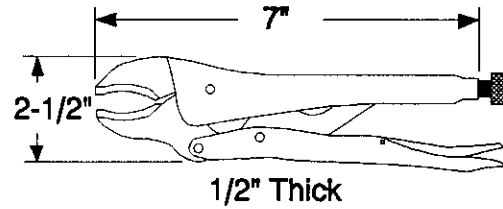

1

Helpful Hints:

Actual Inventory:

WRENCH - SPANNER ADJ HOOK
1-1/4" TO 3"

NSN 5120-00-277-9075

WT. 1.5 lbs VOL. 3.9 in³

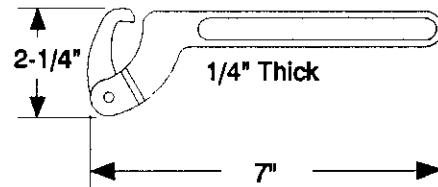

2

Helpful Hints:

Actual Inventory:

WRENCH - CRESCENT
8" LONG - ADJUSTABLE TO .947 IN.
STEEL

NSN 5120-00-240-5328

WT. 0.4 lbs. VOL. 8.5 in.³

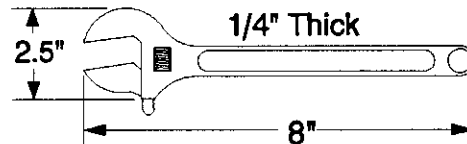

1

Helpful Hints:

Actual Inventory:

DESMOKING EQUIPMENT KIT

AEL Range: 2-880044238 to 4239

A laminated inventory list should be provided with this kit that identifies equipment locations.

DESMOKING EQUIPMENT KIT

Quantity
Required

KIT - DESMOKING EQUIPMENT

1H 0000-LL-CQA-2446

This kit identifies all equipment used for the function of conducting desmoking operations during and after a fire. Individual items are listed on AEL #2-88004238 and in alphabetical order in this guide.

ADAPTER, DUCT 10" MALE

NSN 4730-01-378-5288

WT. 3.0 lbs

VOL. in³

Helpful Hints:

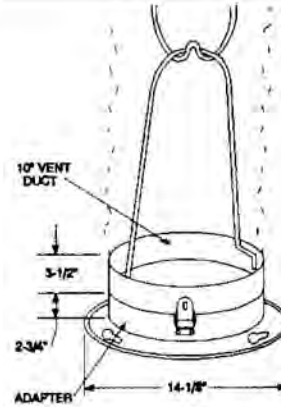

2

Actual Inventory:

BAG-KIT

NSN 8460-00-606-8366

WT. 2.3 lbs

VOL. 5,804.5 in³

Helpful Hints: Utilize stowage bag currently onboard. Reorder as replacement. Used to transport desmoking equipment (small) to scene. DO NOT OVERPACK BAG. Used to stow small equipment items. Replace with color-coded photo-luminescent marked bag, MIL-K-48135, as NAVSEA funds are available.

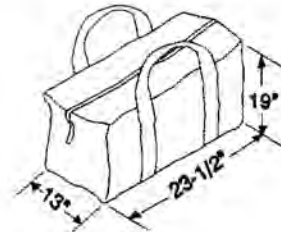

1

Actual Inventory:

CABLE - ASSEMBLY

POWER 25 FT

DESMOKING KIT

NSN 6150-00-449-1189

WT. 2.6 lbs.

VOL. 756.0 in³

Helpful Hints: Provided as NAVSEA funds are available.



1

Actual Inventory:

DESMOKING EQUIPMENT KIT

Quantity
Required

CLAMP SPRING - SMK CTN

9Q 5120-01-121-5023

WT. 6.0 oz

VOL. 29.1 in³

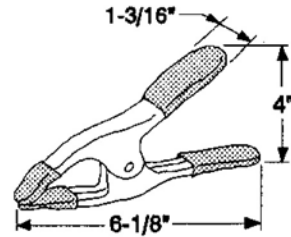

3
Boxes

Helpful Hints:

Additional clamp added to better secure curtain. NAVSEA funds not required. Local purchase suggested (Adjustable Clamp, Chicago, IL) 3 boxes - 12 per box, 24-36 per DCRS.

Actual Inventory:

FAN - TUBEAXIAL
3200 CFM

NSN 4140-01-272-6060

WT. 51.0 lbs.

VOL. 4,692.0 in³

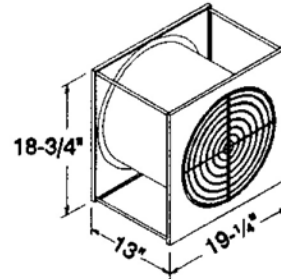

1

Helpful Hints:

Actual Inventory:

FAN - WATER DRIVEN

NSN 3HD 4140-01-333-2224

WT. 35.0 lbs.

VOL. 5,000.0 in.³

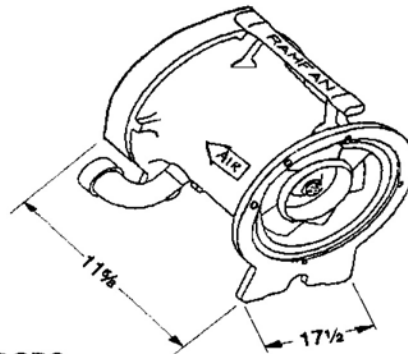

2

Helpful Hints: Replaces Red Devil Blowers.

One for one replacement for each Red Devil Blower in DCRS.
NAVSEA Fleet outfitting completed in 1994.

Actual Inventory:

DESMOKING EQUIPMENT KIT

Quantity
Required

HOSE ASSY - AIR DUCT 10" EXTENDS TO 15'
INTENDED FOR USE WITH PORTABLE WATER
DRIVEN FAN.

NSN 4720-01-378-6044

WT. 21.0 lbs.

VOL. 3000.0 in.³

Helpful Hints:

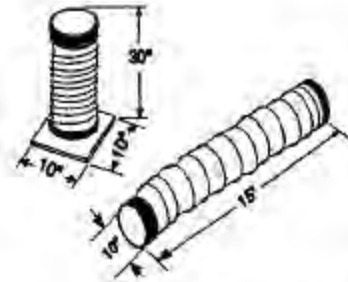

4

Actual Inventory:

KIT, MAINTENANCE GENERAL

NSN 4140-01-339-1293

WT. 2.5 lbs.
in.³

VOL. 240.0

Helpful Hints: Comes with water driven fan, when ordered.

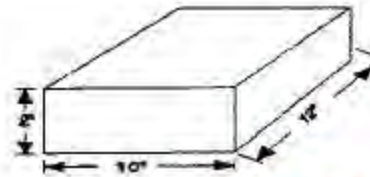

1

DELETE

Actual Inventory:

SMOKE CRTNS - BLANKETS
(STOWED FOLDED)

NSN 4210-01-306-7827

(3 SETS PER DCRS)

WT. 18.0 lbs.

VOL. 720.0 in.³ (folded)

Helpful Hints:



3

Actual Inventory:

DESMOKING EQUIPMENT KIT

Quantity
Required

**SMOKE CRTNS - TWO-PANEL CURTAIN
(STOWED FOLDED)**

NSN 4210-01-306-7826

(3 SETS PER DCRS)

WT. 13.8 lbs.

VOL. 504 in³ (folded)

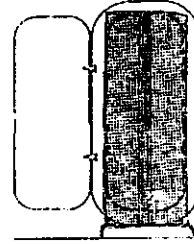

3

Helpful Hints:

Actual Inventory:

DEWATERING EQUIPMENT KIT

AEL Range: 2-880044240 to 4241

Note:

Ensure hoses have been hydro tested IAW PMS.

A laminated inventory list should be provided with this kit that identifies equipment locations.

DEWATERING EQUIPMENT KIT

Quantity
Required

KIT - DEWATERING EQUIPMENT

1HM 0000-LL-CQA-2447

This kit identifies all equipment used for the function of conducting dewatering operations during and after flooding or firefighting. Individual items are listed on AEL #2-88004240 and in alphabetical order in this guide.

BAG-KIT -

NSN 8460-00-606-8366

WT. 2.3 lbs

VOL. 5,804.5 in³

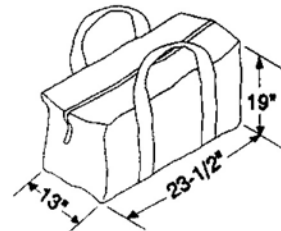

1

Helpful Hints:

Utilize bag of equal size, order kit bag as replacement of present inventory. Used to stow small equipment items. DO NOT OVERPACK BAG. Replace with color - coded photoluminescent marked bag, MIL-K-48135, as NAVSEA funds are available.

Actual Inventory:

CABLE - ASSEMBLY
POWER ELECTRICAL
440 VOLT EXTENSION CORD WITH
RECEPTACLE BOX FOR SUBMERSIBLE
PUMP. 75 FT

NSN 6150-00-087-0815

WT. 37.0 lbs.

VOL. 3468.0 in.³

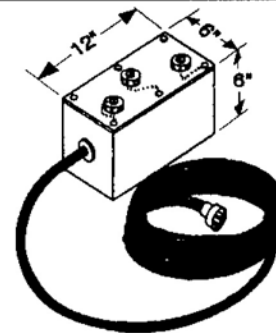

2

Helpful Hints: Electrical safety check item.

Actual Inventory:

DEWATERING EQUIPMENT KIT

Quantity
Required

EDUCTOR - 1-1/2"
1-1/2" INLET x 2-1/2" OUTLET

NSN 4320-00-217-0938

WT. 20.0 lbs. VOL. 2,227.5 in³

Helpful Hints: NAVSEA will outfit in 1993/94.

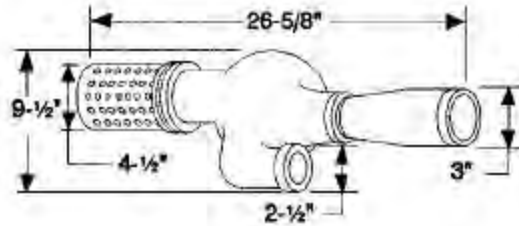

1

Actual Inventory:

EDUCTOR - PERI-JET
2-1/2" INLET x 4" OUTLET

NSN 4320-00-256-8206

WT. 35.0 lbs. VOL. 2,720.0 in³

Helpful Hints:

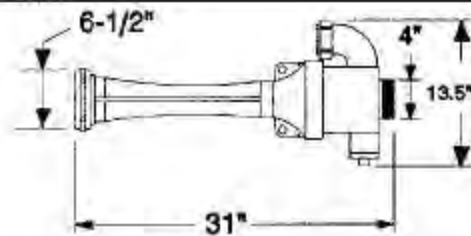

1

Actual Inventory:

GASKET/WASHER - 3" RUBBER

NSN 5330-00-239-1879

WT. 0.2 lbs VOL. 1.4 in³

Helpful Hints: For 3" suction hose coupling.



5

DELETE

Actual Inventory:

GASKET/WASHER - 4" RUBBER

NSN 5310-00-239-1882

WT. 0.2 lbs VOL. 1.5 in³

Helpful Hints: For 4" discharge hose coupling and 4" eductor female connection.



10

DELETE

Actual Inventory:

DEWATERING EQUIPMENT KIT

Quantity
Required

GASKET/WASHER - 1-1/2" NON-METALLIC

NSN 5330-00-239-1873

WT. 0.1 lbs

VOL. 0.5 in³

DELETE



10

Helpful Hints: For 1-1/2" fire hose coupling.

Actual Inventory:

GASKET/WASHER - 2-1/2" NON-METALLIC

NSN 5330-00-246-2914

WT. 0.1 lbs

VOL. 1.3 in³

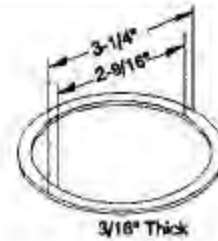

10

Helpful Hints: For 2-1/2" hose coupling.

Actual Inventory:

HOSE ASSEMBLY - 4" x 50 FT.
NON-METALLIC

NSN 4210-01-220-6648

WT. 60.0 lbs.

VOL. 4,064.0 in³

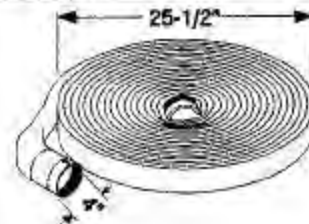

2

Helpful Hints: For eductor discharge.

Actual Inventory:

HOSE ASSEMBLY - HARD SUCTION
2-1/2" x 10 FT.

NSN 4720-00-221-8763

WT. 16.0 lbs.

VOL. 2,430.0 in³

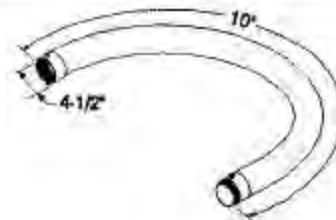

4

Helpful Hints: Stored in vicinity of sub pump/dewatering kit.

Actual Inventory:

DEWATERING EQUIPMENT KIT

Quantity
Required

HOSE - 1-1/2" x 50 FT.
NON-METALLIC

NSN 4210-01-131-0249

WT. 25.0 lbs.

VOL. 1,772.0 in.³

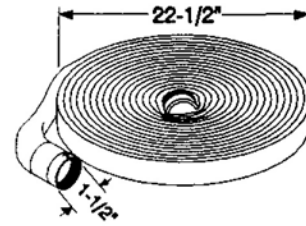

1

Helpful Hints:

Actual Inventory:

HOSE - 2-1/2" x 50 FT.
NON-METALLIC

NSN 4210-01-131-0247

WT. 35.0 lbs.

VOL. 2,890.0 in.³

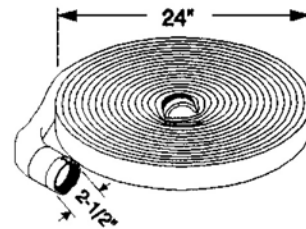

4

Helpful Hints:

Actual Inventory:

PUMP - CENTRIFUGAL
PORTABLE SUBPUMP (BRASS or ALUMINUM)
WITH STRAINER
NSN 4320-00-368-3186

WT. 100.0 lbs.

VOL. 2297.1 in.³

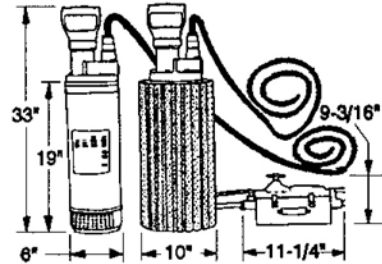

2

Helpful Hints:

APL #017710005. Submersible pump allowance. APL # 2-47004004/5/6. Submersible pump accessories. Electrical safety check item.

Actual Inventory:

HOSE - 1 1/2" x 25 FT
NON-METALLIC

NSN 4210-01-264-3871

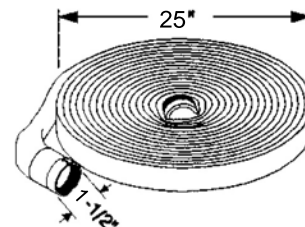

2

Helpful Hints: For use where 50 ft. hose run is not required to reduce friction losses, kinking and excess hose lay out.

Actual Inventory:

DEWATERING EQUIPMENT KIT

Quantity
Required

REDUCER - HOSE
4" (M) TO 3" (F)
USE WITH P-250/EDUCTOR

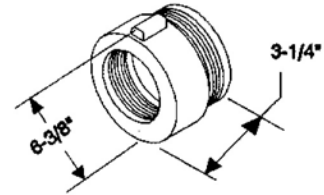

1

NSN 4730-00-618-8593

WT. 11.0 lbs. **VOL.** 132.1 in.³

Helpful Hints:

Actual Inventory:

ROPE - DOUBLE BRAIDED (2" x 50')
(FOR USE ON SUB PUMPS/EDUCTORS)
NSTM CHAPTER 079 VOL II
ARTICLE 079 26.101

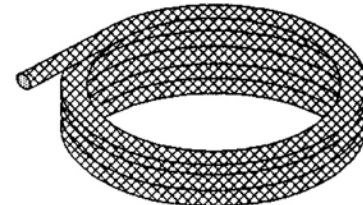

1

1HS0000-LL-CJ7-7143

WT. 5.4 lbs. **VOL.** 200.0 in.³

Helpful Hints: Handling line. Wrap around peri-jet eductor body and attach to submersible pumps. Supplied in 600' roll, cut 50' lengths as required. Only one roll required for up to 12 handling lines.

Actual Inventory:

STRAINER - SUCTION, FRHS - 2-1/2"
FOR SUBMERSIBLE PUMP

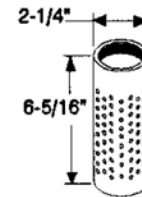

2

NSN 4210-00-289-1539

WT. 5.0 lbs. **VOL.** 26.9 in.³

Helpful Hints: 2-1/2" NPSH thread, Female connector.

Actual Inventory:

HOSE - 1 3/4" x 50 FT.
NON - METALLIC

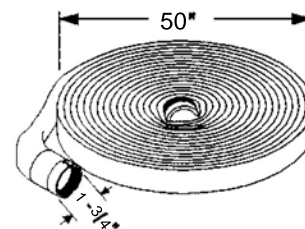

AR

NSN 4210-01-143-1404

Helpful Hints: Hose has 1 1/2" NSPH connectors

Actual Inventory:

DEWATERING EQUIPMENT KIT

Quantity
Required

WRENCH - SPANNER
ADJUSTABLE HOOK WITH FIXED PIVOT
RANGE FROM 2" TO 4-3/4"

NSN 5120-00-277-9076

WT. 2.0 lbs.

VOL. 6.7 in.³

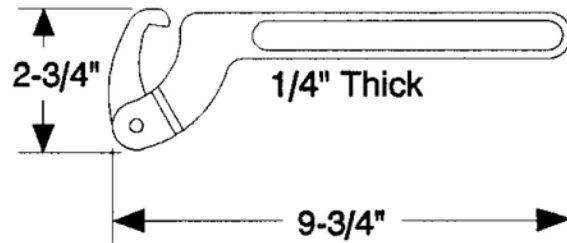

2

Helpful Hints:

Actual Inventory:

WRENCH - SPANNER
3/4" TO 2"

NSN 5120-00-288-8746

WT. 1.3 lbs

VOL. 3.0 in.³

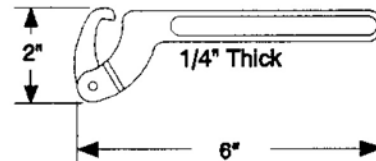

2

Helpful Hints:

Actual Inventory:

ADAPTER DBL (M) 4", NHT

IH 00-LL-CQA-0077

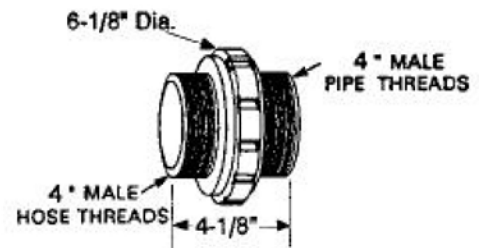

1

**DELETE
This Kit**

**ELECTRICAL CABLE
REPAIR
KIT**

AEL Range: 2-880044242

A laminated inventory list should be provided with this kit.

ELECTRICAL CABLE REPAIR KIT

Quantity
Required

KIT - ELECTRICAL CABLE REPAIR-DC

1H M0000-LL-CQA-2448

This kit identifies equipment used for the function of making electrical cable repair. For more information, see Electrical Cable Repair Crimping Tool-HYDRA, Electrical Cable Repair Crimping Tool-STRIPPER, Electrical Cable Repair Manuals (OPER X TOOLS, OPER X SERV), and Electrical Cable Repair Kit in this section.

1
Eng
DCRS
only

Helpful Hints: This complete kit has been provided to some ships.

ELECTRICAL CABLE REPAIR -
CRIMPING TOOL - HYDRA

NSN 5180-01-220-1807
1HS0000-LL-CQA-0132

WT. 60.0 lbs. VOL. 892.5 in³

DELETE

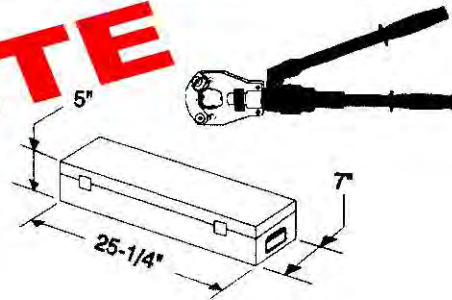

1

Helpful Hints:

Actual Inventory:

ELECTRICAL CABLE REPAIR -
CRIMPING TOOL - WIRE STRIPPER

1HM0000-LL-CQA-0003

WT. 0.5 lbs. VOL. 4.0 in³

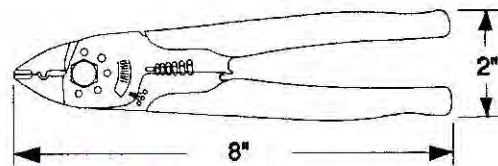

1

Helpful Hints:

Actual Inventory:

DELETE

ELECTRICAL CABLE REPAIR KIT

Quantity
Required

ELECTRICAL CABLE REPAIR-MANUAL -
OPER X TOOL

1HS0000-LL-CQA-0135

WT. 1.5 lbs.

VOL. 46.8 in³

Helpful Hints:

1/2"
Thick

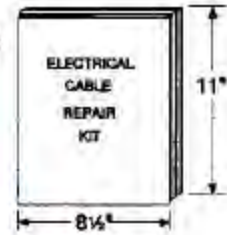

1

DELETE

Actual Inventory:

ELECTRICAL CABLE REPAIR-MANUAL -
OPER X SERV
1HS0000-LL-CQA-0136

WT. 1.5 lbs.

VOL. 46.8 in³

Helpful Hints:

1/2"
Thick

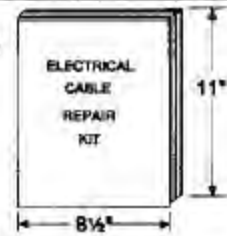

1

DELETE

Actual Inventory:

ELECTRICAL CABLE REPAIR KIT

Quantity
Required

ELECTRICAL CABLE REPAIR - KIT

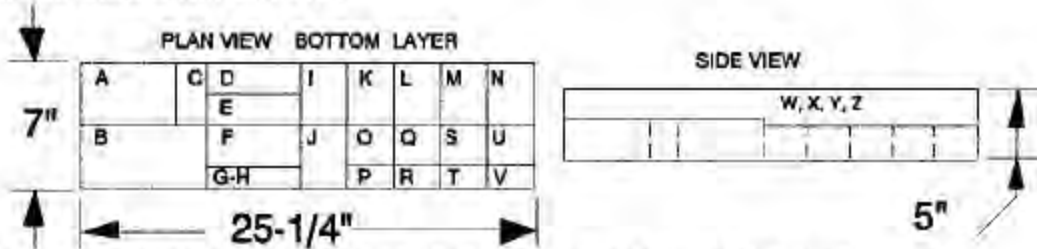

- 1HS0000-LL-CQA-0139 A - Compression Splice 500 MCM Max. 4/0 Min. AWG
- 1HS0000-LL-CQA-0141 B - Compression Terminal 500 MCM Max. 4/0 Min. AWG
- 1HM0000-LL-CQA-0014 C - Compression Terminal 1/0 Max. #6 Min. AWG
- NSN 5940-01-186-0063 D - Compression Terminal 3/0 Max. #2 Min. AWG
- 1HM0000-LL-CQA-0015 E - Compression Terminal #2 Max. #8 Min. AWG
- 1HS0000-LL-CQA-0140 F - Compression Terminal 250 MCM Max. 1/0 Min.
- 1HS0000-LL-CQA-0134 G - Repair Kit
- 1HS0000-LL-CQA-0133 H - Test Gage and Slugs
- 1HM0000-LL-CQA-0010 I - Compression Splice 1/0 Max. #8 Min.
- 1HS0000-LL-CQA-0138 J - Compression Splice 250 MCM Max. #1/0 Min.
- 1HM0000-LL-CQA-0011 K - Compression Splice 3/0 Max. #4 Min.
- 1HM0000-LL-CQA-0009 L - Compression Splice #2 Max. #8 Min.
- 1HM0000-LL-CQA-0013 M - Compression Terminal #6 Max. #8 Min.
- 1HM0000-LL-CQA-0008 N - Compression Splice #6 Max. #8 Min.
- 1HS0000-LL-CQA-0142 O - Butt Splice #12 - #10
- NSN 5940-01-087-0285 P - Locking Spade #16 - #14, #10 Stud
- 1HM0000-LL-CQA-0018 Q - Butt Splice #16 - #14
- NSN 5940-01-078-2936 R - Locking Spade #16 - #14, #8 Stud
- NSN 5940-00-551-2446 S - Locking Spade #16 - #10, #10 Stud
- 1HM0000-LL-CQA-0020 T - Locking Spade #22 - #18, #8 Stud
- NSN 5940-00-143-5147 U - Butt Splice #22 - #18
- NSN 5940-01-008-6728 V - Locking Spade #22 - #28, #6 Stud
- 1HS0000-LL-CQA-0132 W - Hydraulic Tool #6 - 750 MCM AWG
- 1HM0000-LL-CQA-0003 X - Manual Crimping Tool #22 - #10 AWG
- 1HM0000-LL-CQA-0004 Y - Tool Oil - 1/2 Pt
- 1HS0000-LL-CQA-0137 Z - Technical Manual

DELETE

WT. 60.0 lbs. VOL. 883.7 in³

Helpful Hints:

Actual Inventory:

ELECTRICAL REPAIR KIT

AEL Range: 2-880044243 to 4244

Ensure that all tools (metal) are provided with electrical insulation (either electrical tape wrap or plastisol coated) as prescribed in MIL-P-20689.

ELECTRICAL REPAIR KIT

Quantity
Required

KIT - ELECTRICAL REPAIR-DC

1H 0000-LL-CQA-2449

Used in damage control repair stations by qualified repair party electricians, this kit identifies all equipment used for the function of providing repairs to electrical panels, lighting, wireways and portable electrical equipment.

BAG-TOOL SATCHEL -

NSN 5140-00-293-2379

WT. 3.9 lbs

VOL. 11,248.0 in³

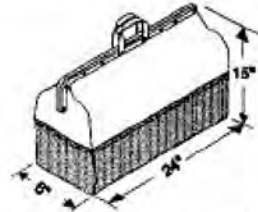

1

Helpful Hints: Utilize stowage bag currently onboard. Reorder as a replacement. Bag with tools stored with rubber mat and boots in main DCRS. Replace with color-coded photo-luminescent marked bag, MIL-B-43663, as NAVSEA funds are available.

Actual Inventory:

BELT - TOOL ADJUSTABLE

NSN 5140-00-391-1069

WT. 1.0 lbs.

VOL. 22.5 in³

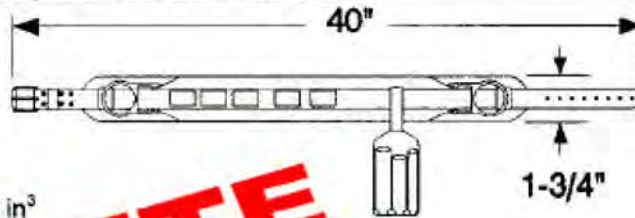

1

Helpful Hints:

DELETE

Actual Inventory:

BLADE - HACKSAW 12"

Teeth Size
(24 Teeth per inch)

NSN 5110-00-277-4590
(BOX OF 10)

WT. 0.5 lbs.

VOL. 3.8 in³

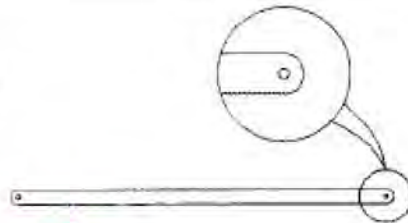

1

Helpful Hints:

DELETE

Actual Inventory:

ELECTRICAL REPAIR KIT

Quantity
Required

KIT - ELECTRICAL REPAIR-DC

1H 0000-LL-CQA-2449

Used in damage control repair stations by qualified repair party electricians, this kit identifies all equipment used for the function of providing repairs to electrical panels, lighting, wireways and portable electrical equipment.

BAG-TOOL SACHEL -

NSN 5140-00-293-2379

WT. 3.9 lbs

VOL. 11,248.0 in³



1

Helpful Hints: Utilize stowage bag currently onboard. Reorder as a replacement. Bag with tools stored with rubber mat and boots in main DCRS.

Actual Inventory:

BELT - TOOL ADJUSTABLE

NSN 5140-00-391-1069

WT. 1.0 lbs.

VOL. 22.5 in³

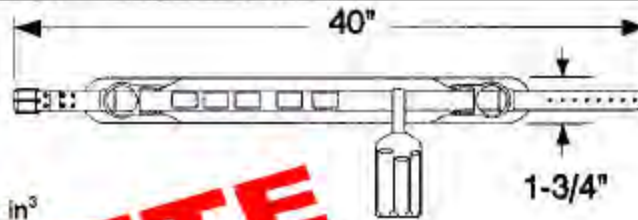

1

Helpful Hints:

DELETE

Actual Inventory:

BLADE - HACKSAW 12"

NSN 5110-00-277-4590
(BOX OF 10)

WT. 0.5 lbs.

VOL. 3.8 in³

Teeth Size
(24 Teeth per inch)

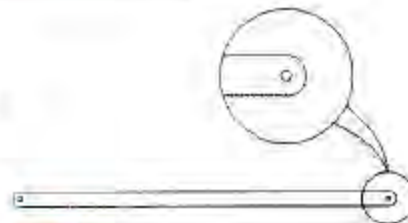

1

Helpful Hints:

DELETE

Actual Inventory:

ELECTRICAL REPAIR KIT

Quantity
Required

CHISEL - COLD HAND

NSN 5110-00-221-8132

WT. 1.3 lbs.

VOL. 2.3 in³

Helpful Hints:

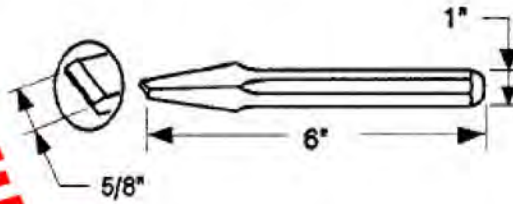

1

DELETE

Actual Inventory:

FACE SHIELD -

NSN 4240-00-542-2048

WT. 0.8 lbs.

VOL. 640.0 in³

Helpful Hints:



1

Actual Inventory:

FRAME - HAND HACKSAW
PISTOL GRIP, ADJUSTABLE FOR 10" TO
12" BLADES.

NSN 5110-00-289-9657

WT. 2.4 lbs.

VOL. 90.2 in³

Helpful Hints:

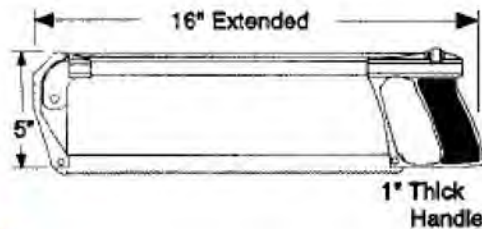

1

DELETE

Actual Inventory:

CASUALTY POWER - DANGER -
HIGH VOLTAGE SIGN

1HS0000-LL-CJ7-5883
(PACKAGE OF 20)

WT. 1.0 lbs.

VOL. 72.0 in³

Helpful Hints:



10

Actual Inventory:

ELECTRICAL REPAIR KIT

Quantity
Required

- DOUBUSACTING
10 AMP TIME DELAY
15 AMP QUICK ACTING FUZE

NSN 5920-00-823-0571

WT. 0.4 lbs.

VOL. 12.1 in.³



6

Helpful Hints: Used for submersible pumps. Three fuses are used in each switch box for the 3 phases.

Actual Inventory:

FUSE - VARIOUS

NSN VARIOUS

WT. 0.4 lbs.

VOL. 12.1 in.³



Helpful Hints: Shipboard electrician shall select fuse types for equipment and fuse boxes that are within DCRS area of responsibility.

Actual Inventory:

HAMMER - BALLPEEN
MACHINIST 1 LB.
14-1/2" HANDLE (HICKORY)

5120-00-061-8543

WT. 1.5 lbs

VOL. 54.4 in.³

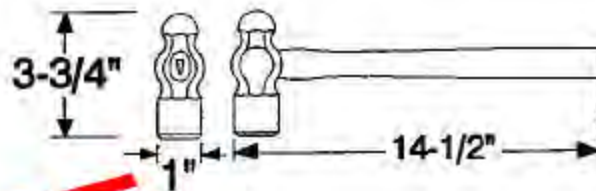

1

Helpful Hints:

Actual Inventory:

ELECTRICAL REPAIR KIT

Quantity
Required

INDICATOR - VOLT FREQUENCY

NSN 6625-00-132-1196

WT. 0.8 lbs.

VOL. 65.0 in³

OLD STYLE

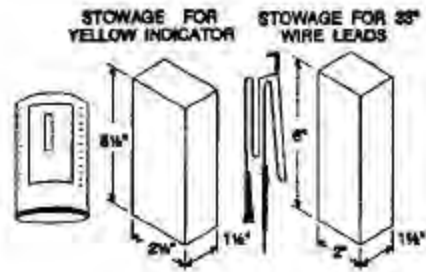

1

Helpful Hints:

Actual Inventory:

MATTING - RUBBER

15" x 18" x 1/8"

ELECTRICAL REPAIR

NSN 7220-00-267-4630

WT. 7.0 lbs.

VOL. 67.5 in³

DELETE

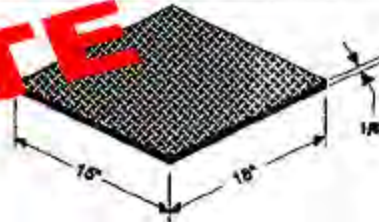

1

Helpful Hints: Stored with bag, tool satchel rolled and attached to bag in main DCRS.
Cut from 36" x 25 yd. roll.

Actual Inventory:

PLIERS - DIAGONAL CUTTING 6"

NSN 5110-00-239-8253

WT. 5.0 oz

VOL. 3.7 in³

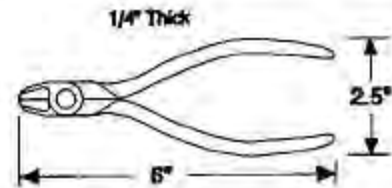

Helpful Hints:

Actual Inventory:

ELECTRICAL REPAIR KIT

Quantity
Required

PLIERS - LINEMAN 8"

NSN 5120-00-239-8251

WT. 7.0 oz

VOL. 5.0 in³

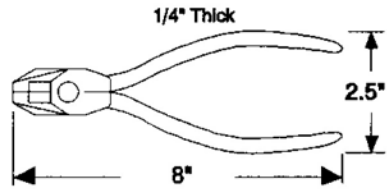

1

Helpful Hints:

Actual Inventory:

PLIERS - SLIP JOINT 8"

NSN 5120-00-223-7397

WT. 8.0 oz

VOL. 10.5 in³

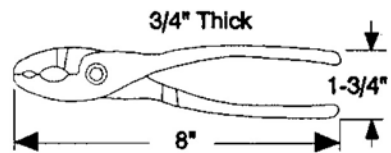

1

Helpful Hints:

Actual Inventory:

PP-BOOTS - FIREMAN

1H 0000-LL-CJ6-8462 SELECT SIZE
(PAIR)

WT. 6.7 lbs

VOL. 1,073.2 in³

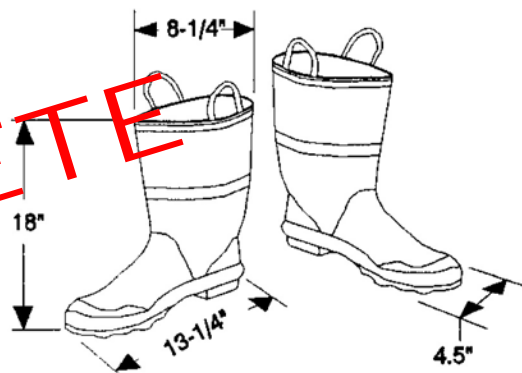

1

Helpful Hints: Stored with bag, tool satchel, and matting in main DCRS.

Actual Inventory:

ELECTRICAL REPAIR KIT

Quantity
Required

PP-GLOVES - RUBBER
7500 VOLT

NSN 8415-01-158-9450
(PAIR)

WT. 1.0 lb VOL. 77.0 in³

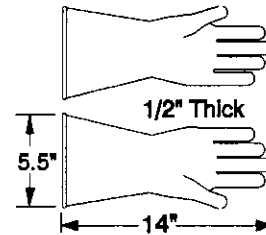

1

Helpful Hints: Gloves, electrical

Actual Inventory:

PP-GLOVES - SHELL ELEC - LEATHER

NSN 8415-00-264-3618
(PAIR)

WT. 1.5 lbs VOL. 84.0 in³

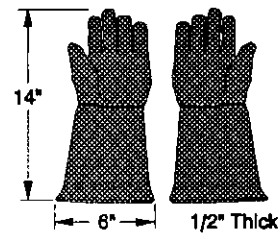

1

Helpful Hints: Shell to be worn over electrical gloves for protection.

Actual Inventory:

PP-POWDER - TALC

NSN 8510-00-817-0295

WT. 6.0 oz VOL. 37.5 in³

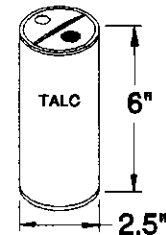

1

Helpful Hints: Not funded by NAVSEA. Previous safety requirement.

Actual Inventory:

PULLER - FUSE
SIZE 3

NSN 5120-00-243-2776

WT. 2.0 oz VOL. 12.0 in³

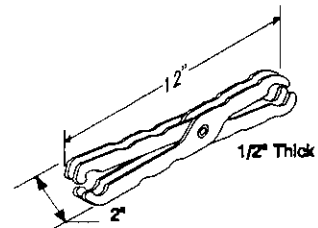

1

Helpful Hints:

Actual Inventory:

ELECTRICAL REPAIR KIT

Quantity
Required

PULLER - TY B

NSN 5120-00-224-9456

WT. 1.5 oz

VOL. 7.0 in³

Helpful Hints:

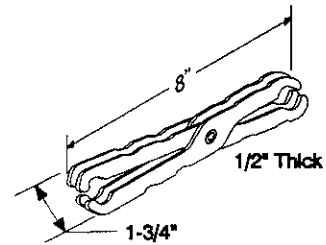

1

Actual Inventory:

SCREWDRIVER - CROSS TIP (PHILLIPS)

NSN 5120-00-542-3438

WT. 0.8 lbs

VOL. 13.7 in³

Helpful Hints:

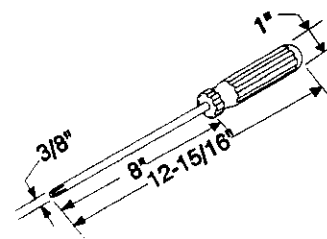

1

Actual Inventory:

SCREWDRIVER - FLAT TIP

1/4" x 4"

NSN 5120-00-764-8058

WT. 0.3 lbs

VOL. 6.4 in³

Helpful Hints:

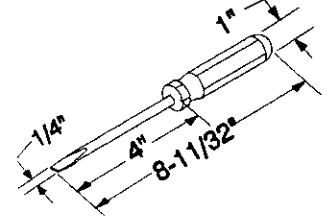

1

Actual Inventory:

SCREWDRIVER - FLAT TIP

3/8" x 10"

NSN 5120-00-293-3309

WT. 0.8 lbs

VOL. 13.7 in³

Helpful Hints:

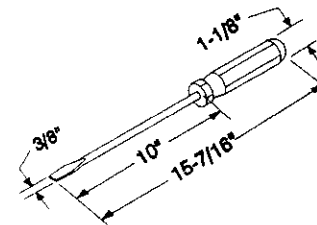

1

Actual Inventory:

ELECTRICAL REPAIR KIT

Quantity
Required

SPECTACLES - INDUSTRIAL
24 MM BRIDGE
W/PERFORATED SIDE SHIELDS
NSN 4240-00-516-4531

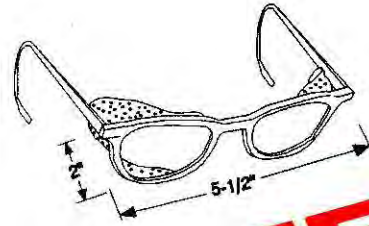

1

WT. 0.1 lbs VOL. 20.0 in³

Helpful Hints: Replacement for goggles. Better visibility and safety.

DELETE

Actual Inventory:

SPECTACLES - INDUSTRIAL
20 MM BRIDGE
W/PERFORATED SIDE SHIELDS
NSN 4240-00-516-4728



1

WT. 0.1 lbs VOL. 20.0 in³

Helpful Hints: Replacement for goggles. Better visibility and safety.

DELETE

Actual Inventory:

STRIPPER-CABLE - HAND
3/8" x 1-5/8"

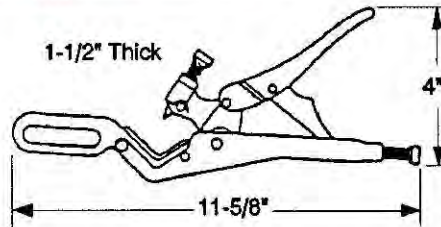

1

NSN 5110-00-238-7696

WT. 1.2 lbs. VOL. 22.5 in³

Helpful Hints:

Actual Inventory:

TAPE - INSULATION ELEC BLK
3/4" WIDE ROLL - 3" DIA
66 FT LONG
NSN 5970-00-185-8531



1

WT. 0.3 lbs VOL. 9.2 in³

ELECTRICAL TAPE
(BLACK)

Helpful Hints:

Actual Inventory:

ELECTRICAL REPAIR KIT

Quantity
Required

TAPE - INSULATION ELEC WHITE
3/4" WIDE ROLL - 3" DIA (F TYPE)

NSN 5970-00-686-9151

WT. 0.3 lbs

VOL. 6.7 in³



1

ELECTRICAL TAPE
(WHITE)

Helpful Hints:

DELETE

Actual Inventory:

TWINE - HEMP FIBROUS

NSN 4020-00-231-5870

WT. 1.0 lb

VOL. 64.0 in³

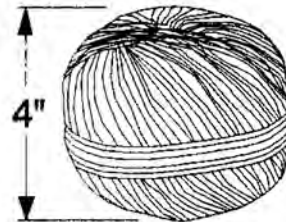

1

Helpful Hints:

Actual Inventory:

WRENCH - CRESCENT
8" LONG - ADJUSTABLE TO .947 IN.
STEEL

NSN 5120-00-240-5328

WT. 0.4 lbs.

VOL. 8.5 in.³

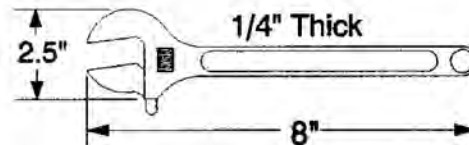

1

Helpful Hints:

Actual Inventory:

PP-Lantern Head
9G-6230-01-285-4396

DELETE

1

REPLACE WITH STEALTHLITE

DELETE
This Kit

ELECTRONIC REPAIR KIT

AEL Range: 2-880044245

Shipboard survivability improvement.
Stowed in Electronic Casualty
Control/Repair Eight (8) / not part of DCRS
inventory. Stowage requirement. A
laminated inventory list should be provided
with this kit.

ELECTRONIC REPAIR KIT

Quantity
Required

KIT - ELECTRONIC REPAIR-DC

1H 0000-LL-CQA-2450

This kit identifies all equipment used for the function of providing repair to vital electronic equipment support systems during battle. Individual items are listed on AEL #2-880044245 and in alphabetical order in this guide.

Helpful Hints: Stored in Electronics Casualty Control / Repair 8.

DELETE

BAG-TOOL SACHEL -

NSN 5140-00-293-2379

WT. 3.9 lbs

VOL. 11,248.0 in³

Helpful Hints:



1

DELETE

Actual Inventory:

KIT - EMERGENCY COMM-DC

1H 0000-LL-CQA-2451

This kit identifies all equipment used for the function of providing emergency communications at battle stations or other general shipboard casualties.

Helpful Hints: Utilize onboard equipment.

2

DELETE

Actual Inventory:

PP-GLOVES - RUBBER
7500 VOLT

NSN 8415-01-158-9450
(PAIR)

WT. 1.0 lb

VOL. 77.0 in³

Helpful Hints: Previous safety requirement.



2

DELETE

Actual Inventory:

ELECTRONIC REPAIR KIT

Quantity
Required

PP-GLOVES - SHELL ELEC

NSN 8415-00-264-3618
(PAIR)

WT. 1.5 lbs VOL. 84.0 in³

Helpful Hints: Previous safety requirement.



2

DELETE

Actual Inventory:

PP-HELMET - PHONE TALKER
MARK 4 MOD 0

NSN 8470-01-127-7337

WT. 4.0 lbs. VOL. 1,124.0 in³

Helpful Hints:

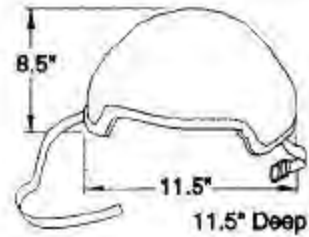

1

DELETE

Actual Inventory:

EMERGENCY COMMUNICATIONS KIT

AEL Range: 2-880044246 to 4247

A laminated inventory list should be provided with this kit.

EMERGENCY COMMUNICATIONS KIT

Quantity
Required

KIT - EMERGENCY COMM-DC

1H 0000-LL-CQA-2451

This kit identifies all equipment used for the function of providing emergency communications at battle stations or other general shipboard casualties.

BAG, LINEMAN TOOL -

NSN 5140-00-288-7763

WT. 3.1 lbs

VOL. 594.0 in³

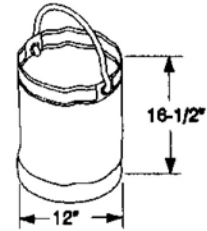

1

Helpful Hints:

Utilize existing stowage bag onboard. Not to exceed 18" in dia/width. Order this bag as a replacement. Replace with color-coded photo-luminescent marked bag, GGG-B-50, as NAVSEA funds are available.

Actual Inventory:

CABLE - TEL TY MR-1-D-1

NOTE: SALT/PEPPER WIRE TWISTED,
STRANDED COPPER CONDUCTOR.

NSN 6145-00-922-8592

WT. 8.0 lbs.

VOL. 189.0 in.³

DELETE

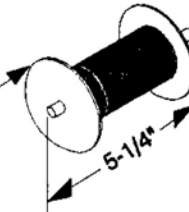

1

Helpful Hints: Cable wrapped onto reel.

Actual Inventory:

**HEADSET CHEST SET -
SOUND POWER PHONES**

NSN 5965-00-900-6401

WT. 4.0 lbs

VOL. 472.9 in.³

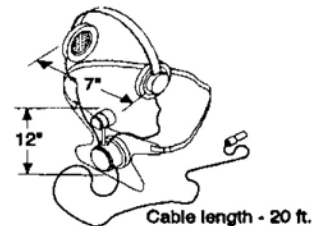

2

Helpful Hints:

Actual Inventory:

EMERGENCY COMMUNICATIONS KIT

Quantity
Required

JACK - BOX-TY G15 B

NSN 5935-00-552-6790

WT. 1.8 lbs.

VOL. 21.5 in³

Helpful Hints:

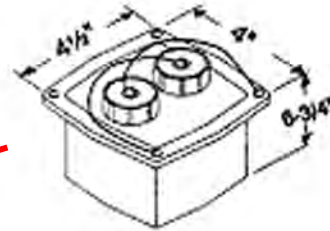

2

DELETE

Actual Inventory:

JACK - TELEPHONE
ONE EACH TELEPHONE LINE

NSN 5935-00-258-8947

WT. 0.3 lbs.

VOL. 13.5 in³

Helpful Hints: Connected to cable/reel.

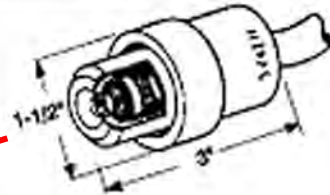

1

DELETE

Actual Inventory:

MESSAGE BLANKS -
LOCALLY PREPARED
REFER TO CNSL INT 3541.1B PG 4-5

1HS0000-LL-CJA-1884

(PAD OF 100)

WT. 0.5 lbs

VOL. 21.0 in³

Helpful Hints:

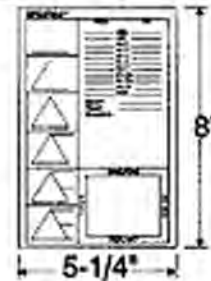

2

DELETE

Actual Inventory:

EMERGENCY COMMUNICATIONS KIT

Quantity
Required

PLUG - TELEPHONE
ONE EACH TELEPHONE LINE

NSN 5935-00-254-9287

WT. 4.0 oz

VOL. 0.5 in³

DELETE

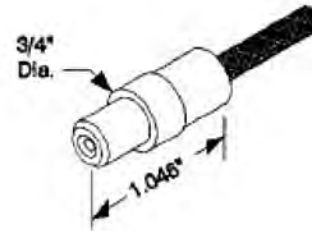

1

Helpful Hints: Connected to cable.

Actual Inventory:

REEL - CABLE
(X40J)

NSN 8130-00-263-8644

WT. 9.0 lbs

VOL. 487.7 in³

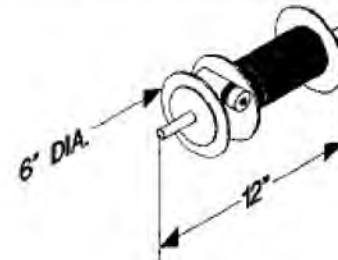

1

Helpful Hints:

Each reel should contain 200 ft. of telephone cable. Telephone jack and plug attached. This NSN will provide orange cable and cable reel assembly.

Actual Inventory:

EMERGENCY LIGHTING KIT

AEL Range: 2-880044248 to 4249

A laminated inventory list should be provided with this kit.

EMERGENCY LIGHTING KIT

Quantity
Required

KIT - EMERGENCY LIGHTING - DC

1H 0000-LL-CQA-2452

This kit identifies all equipment used for the function of providing extension cables and lights where power supply has been interrupted. This is used during shipboard casualties and Condition 1. Individual items are listed on AEL #2-880044248 and in alphabetical order in this guide.

BAG-KIT -

NSN 8460-00-606-8366

WT. 2.3 lbs

VOL. 5,804.5 in³

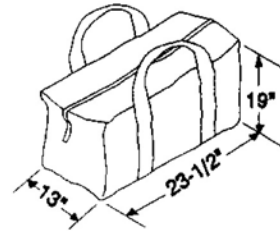

1

Helpful Hints: Utilize existing bag. Not to exceed 18" in dia/width. Order this bag as replacement. Bag used for small equipment items. Replace with color-coded photo-luminescent marked bag, MIL-K-48135, as NAVSEA funds are available.

Actual Inventory:

CABLE - ASSEMBLY

PWR 25 FT

1 OUTLET 3 CONDUCTOR

NSN 6450-00-449-1189

WT. 12.0 lbs.

VOL. 1,512.0 in³

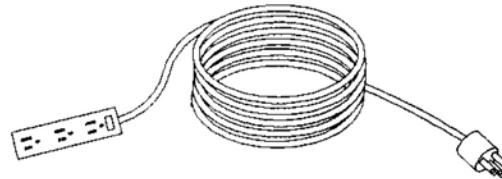

1

Helpful Hints: Multiple outlet.

Provided as NAVSEA funds are available

Actual Inventory:

CABLE - ASSEMBLY

PWR 50 FT

1 OUTLET 3 CONDUCTOR

1HS000-LL-CC1-3787

WT. 5.0 lbs.

VOL. 756.0 in³

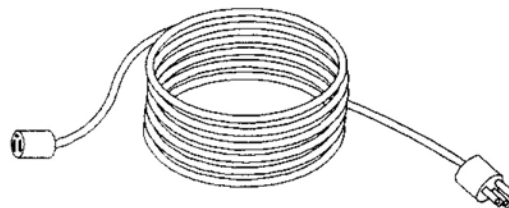

2

Helpful Hints: Fabricate using 50 ft. of NSN 9Z 6145-00-548-1268. 1 each NSN 9N 5935-01-012-3066 and 1 each NSN 9N 5935-01-005-3579. Wire is size 14, 3 conductor OD.610, heavy duty, flexible.

Actual Inventory:

EMERGENCY LIGHTING KIT

Quantity
Required

**LANTERN - ELECTRIC (FLOOD SEAL BEAM)
WET CELL, DAMAGE CONTROL FLOOD TYPE.**

NSN 6230-00-643-3661

WT. 4.0 lbs.

VOL. 99.80 in.³

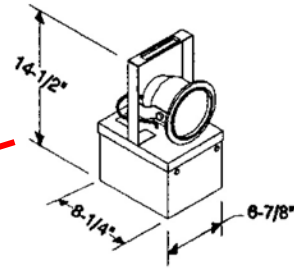

4

Helpful Hints: U.S.S Stark Lessons Learned item. Recommend stowing on rubber mat to prevent battery drainage of wet cell batteries. Kit - Battery Conversion 1HM0099-LL-H40-4396. See AEL 2-880044298.

Actual Inventory:

**LIGHT - EXT
EXPLOSION PROOF, 50 FT.**

NSN 6230-00-701-2947

WT. 10.0 lbs.

VOL. 869.5 in.³

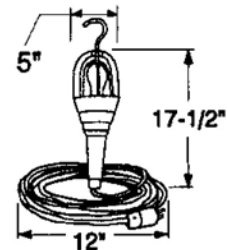

1

Helpful Hints: Stored in bag. Item relocated from parent repair locker AEL.

Actual Inventory:

**WAND - LGT CHMCL HAN YELLOW
BOX OF 10 WANDS**

NSN 6260-01-074-4230

WT. 11.0 oz

VOL. 61.0 in.³

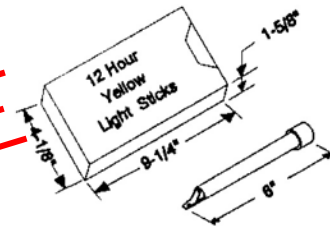

8

Helpful Hints: Chem lights should be stowed in bag.

Actual Inventory:

ENGINEERING SPACES KIT

AEL Range: 2-880044250 to 4251

Shipboard survivability improvement. Stowed in each main engineering/auxiliary space. Not part of DCRS inventory stowage requirement. A laminated inventory list should be provided with this kit.

ENGINEERING SPACES KIT

Quantity
Required

KIT - ENGINEERING SPACE-DC

1H 0000-LL-CQA-2453

This kit identifies all equipment used for the function of providing emergency plugging and pipe patching operations in main and auxiliary engineering spaces. Individual items are listed on AEL #2-880044250 and in alphabetical order in this guide.

BAG-KIT -

NSN 8460-00-606-8366

WT. 2.3 lbs VOL. 5,804.5 in³

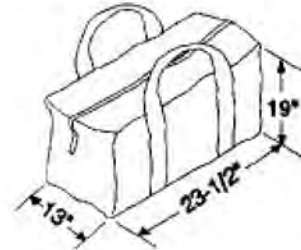

1

Helpful Hints: Replacement item. Utilize existing bags.

Replace with color-coded photo-luminescent marked bag, MIL-K-48135, as NAVSEA funds are available.

Actual Inventory:

BATTERY DRY CELL - BA 200

6 VOLTS
COIL SPRING CONTACTS
PKG OF 6

NSN 6135-00-050-3280

WT. 2.0 lbs. VOL. 29.7 in.³

DELETE



2

Helpful Hints: For battle lantern.

Actual Inventory:

BLADE - HACKSAW 12"

NSN 5110-00-277-4590
(BOX OF 10)

WT. 0.5 lbs. VOL. 3.8 in.³

Teeth Size
(24 Teeth per inch)

DELETE

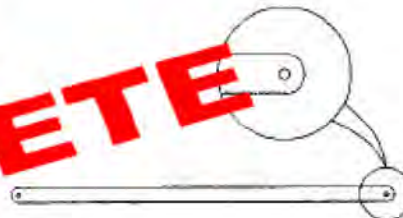

5
bndl

Helpful Hints:

Can substitute 10" blade for 12" blade. Unit of issue = bundle.

Actual Inventory:

ENGINEERING SPACES KIT

Quantity
Required

CANVAS - GRAY DUCK CLOTH
36" WIDE ROLL - 6' LENGTH

NSN 8305-00-193-8794

WT. 2.2 lbs. VOL. 432.0 in³

Helpful Hints: Unit of issue = yards.

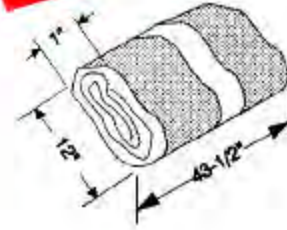

2
yards

Actual Inventory:

CAULKING - IRON-WD TY 2

NSN 5120-00-222-3241

WT. 2.0 lbs. VOL. 7.7 in³

Helpful Hints:

May be fabricated out of 1-1/2" x 1/8" or 3/16" flatbar. Do not use hardened steel.

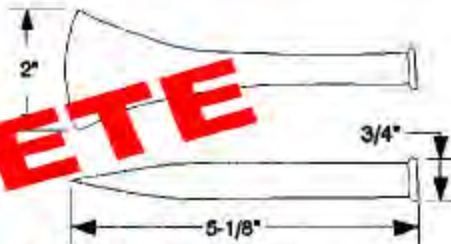

1

Actual Inventory:

CHISEL - COLD HAND

NSN 5110-00-221-8132

WT. 1.3 lbs. VOL. 2.3 in³

Helpful Hints: Cutting edge should be padded/protected

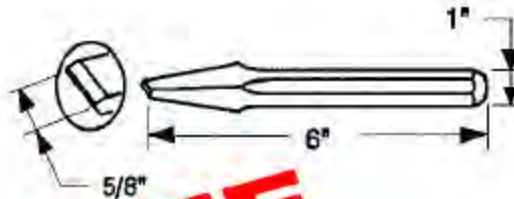

1

Actual Inventory:

CHISEL - FIRMER 1-1/2" X 6-1/4" BLADE

NSN 5110-00-640-5423

WT. 4.0 oz VOL. 8.2 in³

Helpful Hints:

Cutting edge should be padded/sheathed to prevent injury to protect the tool and extend the life of the stowage bag.

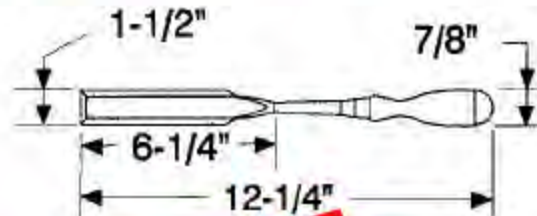

1

Actual Inventory:

ENGINEERING SPACES KIT

Quantity
Required

FRAME - HAND HACKSAW
PISTOL GRIP, ADJUSTABLE FOR 10" TO
12" BLADES.

NSN 5110-00-289-9657

WT. 2.4 lbs. VOL. 90.2 in.³

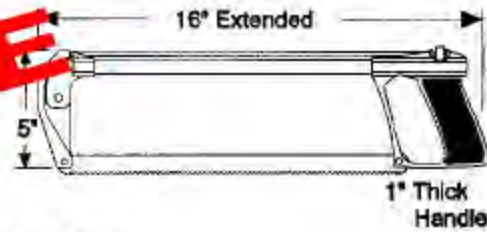

1

Helpful Hints: Recommend providing protective cover for blade.

Actual Inventory:

HAMMER - BALLPEEN
MACHINIST 1 LB.
14-1/2" HANDLE (HICKORY)

5120-00-061-8543

WT. 1.5 lbs VOL. 54.4 in.³

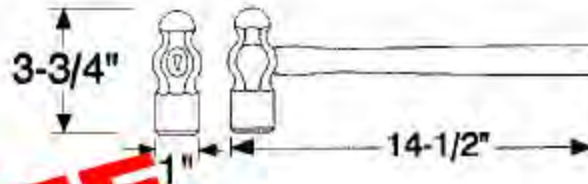

1

Helpful Hints:

Actual Inventory:

HAMMER - RIPPING
CARPENTER'S STRAIGHT CLAW
13" TO 14" HANDLE-FIBERGLASS
1-1/4" LB. HEAD

NSN 5120-00-892-5744

WT. 1.8 lbs. VOL. 105.9 in.³

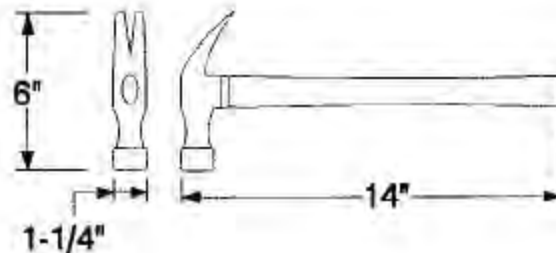

1

Helpful Hints:

Actual Inventory:

ENGINEERING SPACES KIT

Quantity
Required

HATCHET - LATHING
NSN 5110-00-223-5379

WT. 2.1-2.6 lbs VOL. 112.5 in³

Helpful Hints:

14" handle (hickory), 2-1/4" cutting edge, head weight 12 to 17 oz. Provide protective cover over cutting edge.

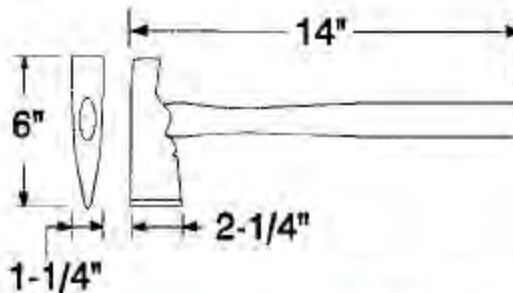

1

Actual Inventory:

LANTERN - BATTLE (ASSEM)

NSN 6230-01-141-2901 - LANTERN
6135-00-050-3280 - BATTERY

WT. 5.5 lbs VOL. 210.0 in³

DELETE



1

Helpful Hints: Stow on rubber insulated surface to prevent battery drainage. Requires two dry 6 volt batteries.

Actual Inventory:

MARLINE-TAR - 2 PLY

NSN 4020-00-240-2185

WT. 0.5 lbs. VOL. 64.0 in³

DELETE



1

Helpful Hints: Cut 131 ft. Wrap on 12" broom handle stock. Stow in kit.

Actual Inventory:

MAUL - SHIP
5 LB., 32" HANDLE

NSN 5120-00-255-1476

WT. 6.7 lbs. VOL. 542.5 in³



1

Helpful Hints:

DELETE

Actual Inventory:

ENGINEERING SPACES KIT

Quantity
Required

OAKUM SPUN TAR -

NSN 5330-00-191-5679

WT. 1.0 lbs. VOL. 448.0 in³

DELETE



1
lbs

Helpful Hints: Cut 1 lb. Stow in kit. Provide protective package. Stow remainder in DCRS.

Actual Inventory:

PLUG - WOOD, TAPERED
10" x 7" DIA x 12"

NSN 5510-00-260-8949

WT. 15.9 lbs VOL. 688.0 in³

DELETE



1

Helpful Hints:

Actual Inventory:

PLUG - WOOD, TAPERED
1" x 0" DIA x 3"

NSN 5510-00-260-8953

WT. 1.0 oz VOL. 0.7 in³

DELETE

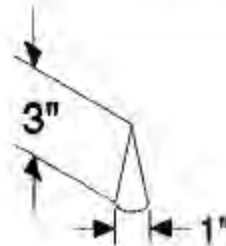

2

Helpful Hints:

Actual Inventory:

ENGINEERING SPACES KIT

Quantity
Required

PLUG - WOOD, TAPERED
2" x 0" DIA x 4"

NSN 5510-00-260-8958

WT. 0.1 lbs VOL. 4.2 in³

Helpful Hints:

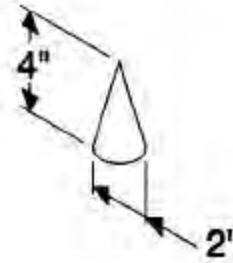

2

Actual Inventory:

PLUG - WOOD, TAPERED
3" x 0" DIA x 8"

NSN 5510-00-260-8962

WT. 0.4 lbs VOL. 18.8 in³

Helpful Hints:

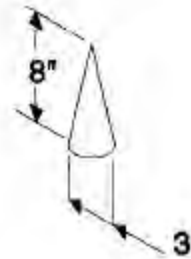

2

Actual Inventory:

PLUG - WOOD, TAPERED
5" x 1" DIA x 10"

NSN 5510-00-260-8966

WT. 1.9 lbs VOL. 50.0 in³

Helpful Hints:

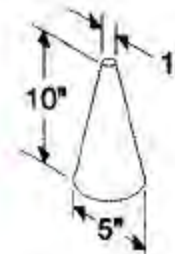

5

Actual Inventory:

PLUG - WOOD, TAPERED
7" x 3" DIA x 10"

NSN 5510-00-260-8969

WT. 4.8 lbs VOL. 206.8 in³

Helpful Hints:

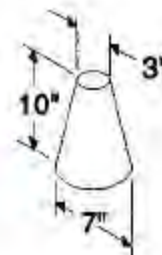

1

Actual Inventory:

DELETE

DELETE

ENGINEERING SPACES KIT

Quantity
Required

PLUG - WOOD, TAPERED
8" x 4" DIA x 10"

NSN 5510-00-260-8973

WT. 6.8 lbs **VOL. 293.2 in³**

Helpful Hints:

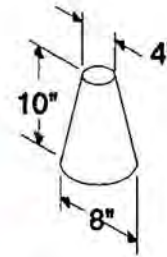

1

DELETE

Actual Inventory:

RULE - MULTIPLE FOLDING

NSN 5210-00-293-3393

WT. 1.2 lbs. **VOL. 4.8 in.³**

Helpful Hints:

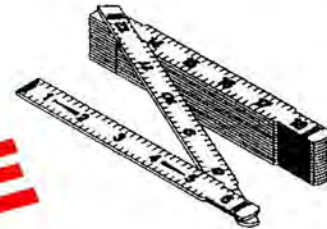

1

DELETE

Actual Inventory:

SAW - HAND 26"
CROSS CUT - BEVEL FILED TEETH
SPRING SET

NSN 5110-00-596-0921

WT. 2.6 lbs. **VOL. 169.0 in.³**

Helpful Hints:

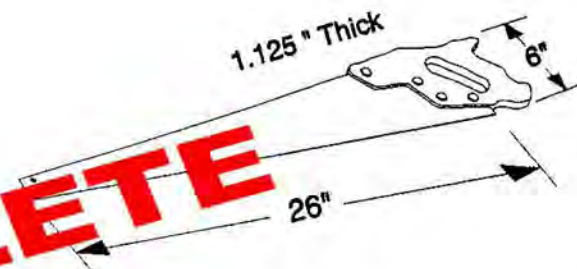

1

DELETE

Recommend providing protective cover (split fire hose) over saw teeth. Do not tape over saw teeth. Replace with 15" 9 pt. aggressive cut box saw when available.

Actual Inventory:

SAW - HAND 15", 9pt.
SHORT CUT

NSN 5110-01-428-5240

Helpful Hints: Replaced 26" Cross cut saw.

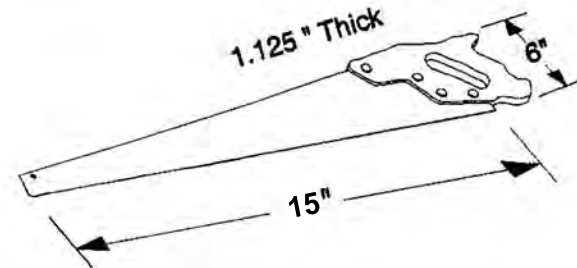

1

Actual Inventory:

ENGINEERING SPACES KIT

Quantity
Required

SHEARS - TAILOR 12"

NSN 5110-00-223-6370

WT. 0.6 lbs. VOL. 9.4 in³

Helpful Hints:

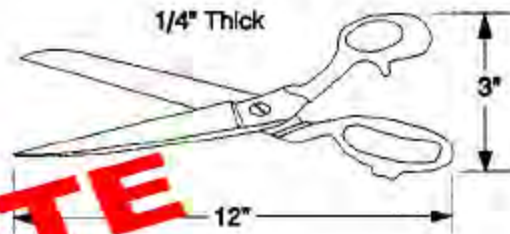

1

DELETE

Actual Inventory:

SHEET - RUBBER SOLID
1/8" X 36" WIDE ROLL - 10 FT LONG

NSN 5330-00-244-0192

WT. 3.0 lbs. VOL. 576.0 in³

Helpful Hints: Cut pieces 20" x 36".

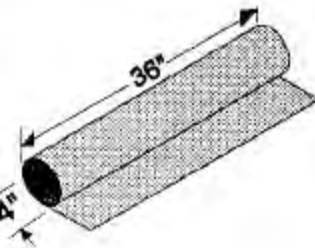

1
roll

DELETE

Actual Inventory:

WAND - LGT CHMCL HAND YELLOW
BOX OF 10 WANDS

NSN 6260-01-074-4230

WT. 11.0 oz VOL. 62.0 in³

Helpful Hints:

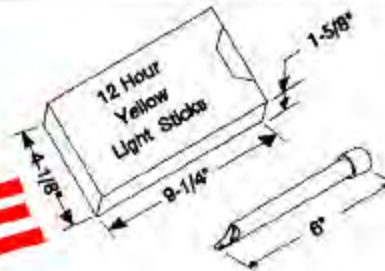

1
box

DELETE

Actual Inventory:

WEDGES - WOOD
2" x 2" x 8"

NSN 5510-00-268-3479

WT. 0.4 lbs VOL. 16.0 in³

Helpful Hints:

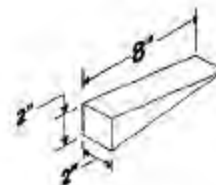

2

Actual Inventory:

ENGINEERING SPACES KIT

Quantity
Required

WEDGES - WOOD
2" x 4" x 8"

NSN 5510-00-268-3480

WT. 0.7 lbs **VOL.** 32.0 in³

Helpful Hints:

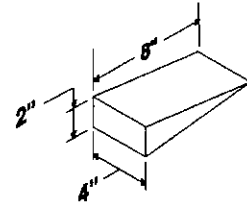

2

Actual Inventory:

WEDGES - WOOD
3" x 3" X 12"

NSN 5510-00-268-3481

WT. 1.2 lbs **VOL.** 54.0 in³

Helpful Hints:

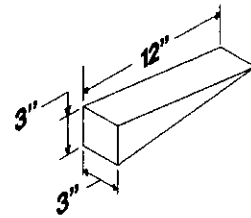

2

Actual Inventory:

WEDGES - WOOD
3" x 6" x 12"

NSN 5510-00-268-3482

WT. 2.5 lbs **VOL.** 108.0 in³

Helpful Hints:

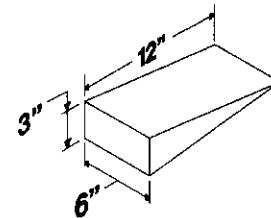

2

Actual Inventory:

**FIREFIGHTING /
ACCESS EQUIPMENT
KIT**

AEL Range: 2-880044252 to 4253

A laminated inventory list should be provided with this kit.

FIREFIGHTING/ACCESS EQUIPMENT KIT

Quantity
Required

KIT - FIRE FIGHTING/ACCESS
EQUIPMENT-DC

1H 0000-LL-CQA-2454

This kit identifies all equipment used for the function of providing access to fire areas. Individual items are listed on AEL #2-880044252 and in alphabetical order in this guide.

AFFF FOAM CONCENTRATE -

NSN 4210-01-056-8343

WT. 45.0 lbs

VOL. 1,983.8 in.³

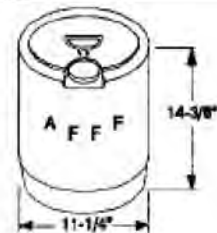

4

Helpful Hints: Can be stowed in rack in passageway.

Actual Inventory:

APPLICATOR NOZZLE - 4 FEET

NSN 4210-00-372-0864

WT. 5.0 lbs.

VOL. 924.0 in.³



1

Helpful Hints:

Actual Inventory:

**AX-PICK HEAD - CARBON STEEL
TYPE II 5" CUTTING EDGE**

NSN 4210-00-142-4949

WT. 8.4 lbs.

VOL. 545.5 in.³

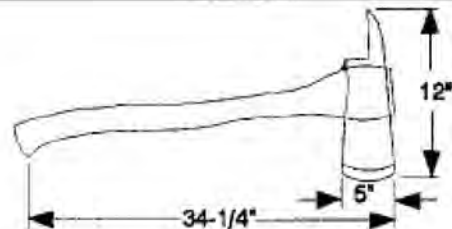

1

Helpful Hints: Recommend providing protective cover for ax blade.

Actual Inventory:

FIREFIGHTING/ACCESS EQUIPMENT KIT

Quantity
Required

BAG, LINEMAN TOOL -

NSN 5140-00-288-7763

WT. 3.1 lbs

VOL. 594.0 in.³

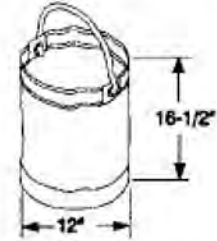

1

Helpful Hints:

New inventory item. Utilize existing bag. Not to exceed 18" in dia/width. Order as replacement. Replace with color-coded photo-luminescent marked bag, GGG-B-50, as NAVSEA funds are available.

Actual Inventory:

BAR CHISEL - 36" PRY BAR

NSN 5110-00-240-6031

WT. 7.0 lbs.

VOL. 40.8 in.³

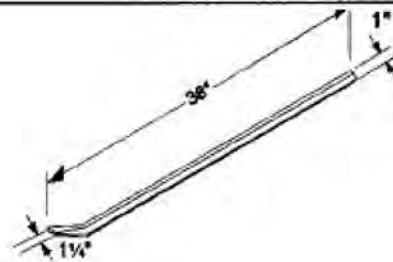

1

Helpful Hints: Replacement item. Utilize 60" pinch bar if onboard.

Actual Inventory:

CUTTER - BOLT

24" LONG 3/8" CAPACITY

CUT WROUGHT IRON, ANNEALED SOFT STEEL
BOLTS, RIVETS, AND COLD DRAWN SCREW STOCK.

NSN 5110-00-596-9156

WT. 7.0 lbs.

VOL. 171.9 in.³

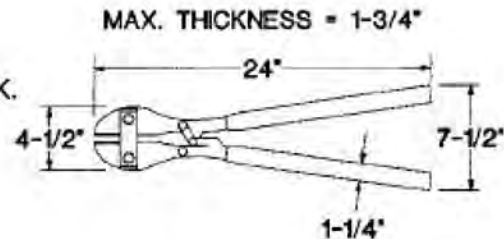

1

Helpful Hints:

Actual Inventory:

FIREFIGHTING/ACCESS EQUIPMENT KIT

Quantity
Required

HAMMER - BLACKSMITH SLEDGE
12 LB.
CROSSPEEN HEAD
34 IN. HANDLE-HICKORY

NSN 5120-00-224-4130

WT. 14.0 lbs.

VOL. 678.1 in.³

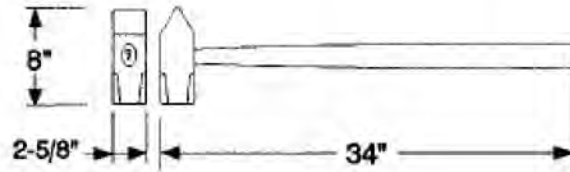

1

Helpful Hints:

Actual Inventory:

HOSE - 1-1/2" x 50 FT.
NON-METALLIC

NSN 4210-01-131-0249

WT. 25.0 lbs.

VOL. 1,772.0 in.³

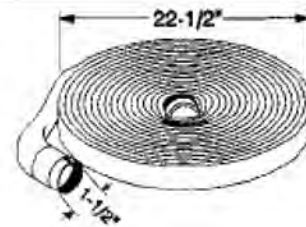

1

Helpful Hints: Ships are to phase replace the 1 1/2" hose with the 1 3/4" firehose (NSN 4210-01-143-1404)

Actual Inventory:

INLINE AFFE DUCTOR -

NSN 4210-01-112-3081

WT. 7.0 lbs.

VOL. 393.7 in³

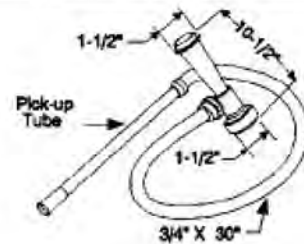

1

Helpful Hints: Can be used with either 1 1/2" or 1 3/4" firehose.

Actual Inventory:

FIREFIGHTING/ACCESS EQUIPMENT KIT

Quantity
Required

LADDER - SCALING

1HS0000-LL-CJ7-5890

WT. 22.0 lbs.

VOL. 7320.0 in.³

Helpful Hints:

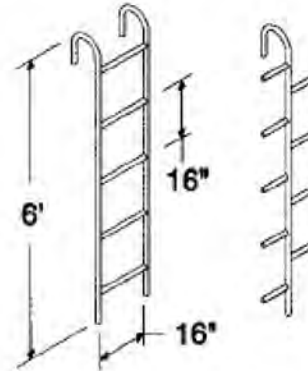

1

To be manufactured by ship's force. NAVSEA dwg #804-5959241. Gen note: Coat entire assembly with plastisol IAW MIL-P-20689 to improve grip and to provide electrical insulation. Utilize ladder onboard. Replace with wide step ladder.

Actual Inventory:

NOZZLE - FIRE HOSE WATER 3 POSITION APN 1-1/2"

NSN 4210-00-392-2943

WT. 10.0 lbs.

VOL. 210.0 in.³

Helpful Hints: Can be used with either 1 1/2" or 1 3/4" firehose.

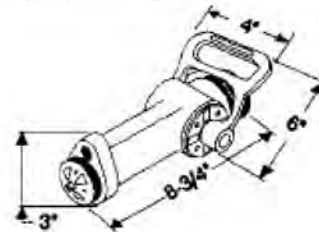

1

Actual Inventory:

NOZZLE - VARIABLE FOAM 2-1/2" TYPE I

NSN 4210-00-465-1904

WT. 13.0 lbs.

VOL. 258.0 in.³

Helpful Hints:

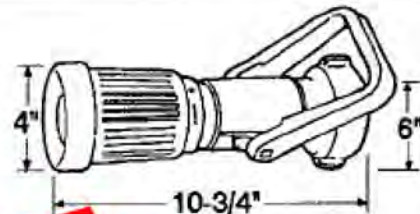

1

Actual Inventory:

DELETE

FIREFIGHTING/ACCESS EQUIPMENT KIT

Quantity
Required

NOZZLE - VARIABLE (BRASS)
1-1/2"

NSN 4210-00-465-1906

WT. 9.0 lbs. VOL. 301.8in³

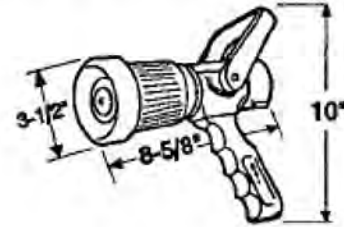

2

Helpful Hints: Can be used with either 1 1/2" or 1 3/4" hose.

Actual Inventory:

RAKE - OVERHAUL

NSN 4210-00-203-3512

WT. 8.0 lbs. VOL. 35.0 in³

Helpful Hints: Replaces overhaul rake fabricated IAW Dwg No. 804-5959242. NAVSEA will provide as funds become available.

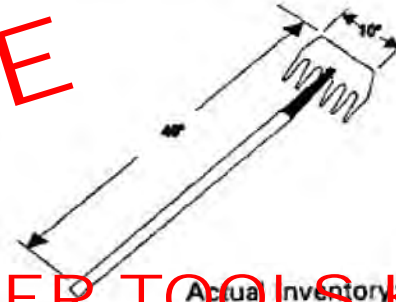

1

Actual Inventory:

SHOVEL - SCOOP

NSN 5120-00-188-8446

WT. 8.5 lbs. VOL. 1,144 in³

Helpful Hints: NAVSEA will provide as funds become available.

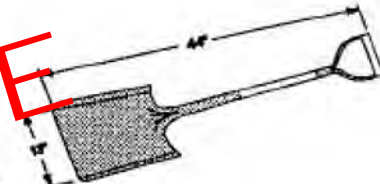

1

Actual Inventory:

WEDGE - JNT BRKG, STEEL
SIZE 4
HARDENED STEEL
3/4" x 1-1/2" x 4"

NSN 5120-00-224-9486

WT. 2.0 lbs.

Helpful Hints: (1" x 1-1/2" butt)

DELETE

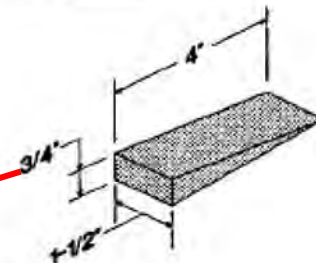

4

Actual Inventory:

FIREFIGHTING/ACCESS EQUIPMENT KIT

Quantity
Required

WEDGE - JNT BRKG, STEEL
SIZE 5
HARDENED STEEL
2" x 2" x 5"

NSN 5120-00-224-9487

WT. 5.0 lbs.

VOL. 10.0 in.³

DELETE

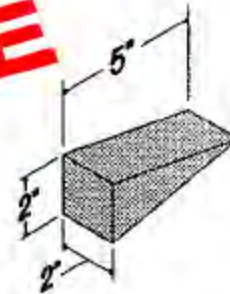

4

Helpful Hints:

Actual Inventory:

WRENCH - SPANNER
ADJUSTABLE HOOK WITH FIXED PIVOT
RANGE FROM 2" TO 4-3/4"

NSN 5120-00-277-9076

WT. 2.0 lbs.

VOL. 6.7 in.³

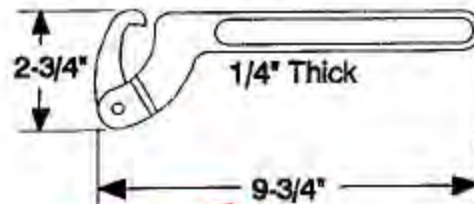

2

Helpful Hints:

Actual Inventory:

WRENCH - SPANNER
3/4" TO 2"

NSN 5120-00-288-8746

WT. 1.3 lbs

VOL. 3.0 in.³

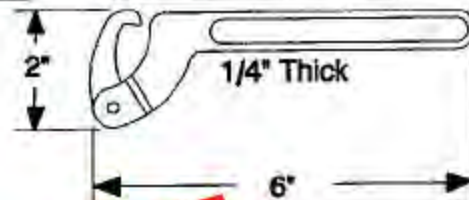

2

Helpful Hints:

Actual Inventory:

DELETE

**FIREFIGHTING /
ACCESS PERSONNEL
KIT**

AEL Range: 2-880044254 to 4255

A laminated inventory list should be provided with this kit.

FIREFIGHTING/ACCESS PERSONNEL KIT

Quantity
Required

KIT - FIREFIGHTING/ACCESS
PERSONNEL-DC

1H 0000-LL-CQA-2455

This kit identifies all equipment used for the function of providing personnel protection to the fire fighter. Individual items are listed on AEL #2-880044254 and in alphabetical order in this guide.

BAG, FIREMAN'S

1HM0000-LL-CQA-2494

WT. 10.0 oz

VOL. 4,788.0 in³

DELETE

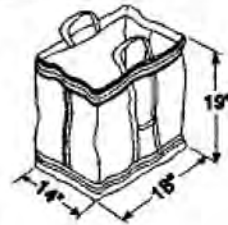

6

Helpful Hints: NAVSEA provided with F/F ensemble coveralls. Bag is an optional stowage device for FFE or can be used to stow other DCRS equipment.

Actual Inventory:

PP-BOOTS - FIREMAN

1H 0000-LL-CJ6-8462 SELECT SIZE

NSN 8430-00-753-5935 SIZE 05
 NSN 8430-00-753-5936 SIZE 06
 NSN 8430-00-753-5937 SIZE 07
 NSN 8430-00-753-5938 SIZE 08
 NSN 8430-00-753-5939 SIZE 09
 NSN 8430-00-753-5940 SIZE 10
 NSN 8430-00-753-5941 SIZE 11
 NSN 8430-00-753-5942 SIZE 12
 NSN 8430-00-753-5943 SIZE 13
 NSN 8430-00-753-5944 SIZE 14
 NSN 8430-00-753-5945 SIZE 15

(PAIR)

WT. 6.7 lbs

VOL. 3,935.2 in³

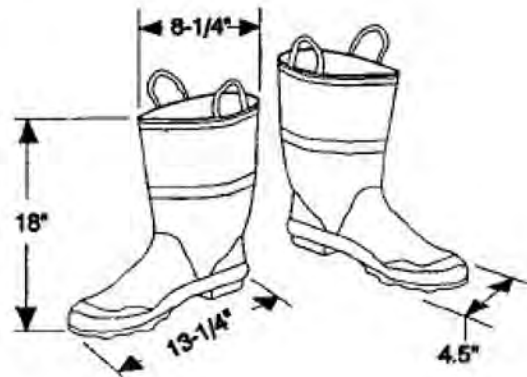

12

Helpful Hints:

Actual Inventory:

FIREFIGHTING/ACCESS PERSONNEL KIT

Quantity
Required

PP-COVERALLS - FFE (FIREFIGHTER ENSEMBLE)

1HM0000-LL-CQA-2200 (SELECT SIZE)
NSN 8415-01-300-6556 SIZE SML
NSN 8415-01-300-6557 SIZE MED
NSN 8415-01-300-6558 SIZE LRG
NSN 8415-01-300-6559 SIZE X-LRG
NSN 8415-01-300-6560 SIZE X-LRG TALL

WT. 5.0 lbs VOL. 3,840.0 in³

Helpful Hints:



12

Actual Inventory:

PP-GLOVES - FIREMAN

1HM0000-LL-CQA-2201 SELECT SIZE
NSN 8415-01-421-1368 SIZE SML
NSN 8415-01-421-1371 SIZE MED
NSN 8415-01-421-1373 SIZE LRG
NSN 8415-01-421-1375 SIZE X-LRG
NSN 8415-01-421-1376 SIZE XX-LRG
(PAIR)

WT. 2.0 lbs. VOL. 108.0 in³

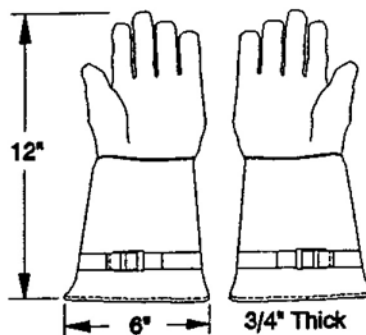

12

Helpful Hints: Status or NSN must be verified prior to ordering. Procure gloves IAW MIL-G-24934/National Fire Protection Association (NFPA) standards.

Actual Inventory:

PP-HELMET - FIREMAN

NSN 8415-01-271-8069

WT. 2.9 lbs VOL. 1,320.0 in³

Helpful Hints:



12

Actual Inventory:

FIREFIGHTING/ACCESS PERSONNEL KIT Quantity
Required

PP-HOOD - ANTIFLASH

NSN 8415-01-268-3473

WT. 2.0 oz

Helpful Hints:

**Phase
Replacement**



12

Actual Inventory:

PP-LANTERN HEAD - (USES FOUR SIZE AA BATTERIES)

NSN 6135-00-985-7845 SIZE AA BATTERIES

NSN 6230-01-285-4396 ASSEMBLY

PHILLIPS HPR-40 OR REPLACEMENT

OSRAM 640721 HALOGEN BULB

WT. 1.0 lbs

VOL. 117.0 in³

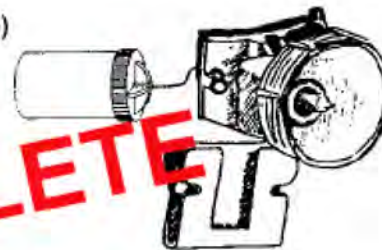

6

Helpful Hints: AA batteries are supplied in packages of 24.

With NDI Replacement

Actual Inventory:

PP-SOCKS - FIREMAN
COTTON/WOOL

NSN 8440-01-053-6388 SZ 7

NSN 8440-01-053-6389 SZ 8

NSN 8440-00-261-4897 SZ 9

NSN 8440-00-153-6717 SZ 10

NSN 8440-00-153-6718 SZ 11

NSN 8440-00-153-6719 SZ 12

NSN 8440-00-153-6720 SZ 13

NSN 8440-00-153-6721 SZ 14

WT. 0.1 lbs

VOL. 7.0 in³



6

Helpful Hints: Worn over regular socks and under Fire Fighting Boot.

Actual Inventory:

GAS FREE ENGINEER KIT

AEL Range: 2-880044260 to 4261

A laminated inventory list should be provided with this kit.

GAS FREE ENGINEER KIT

Quantity
Required

KIT - GAS FREE ENGINEER-DC

1H 0000-LL-CQA-2456

This kit identifies all equipment used for the function of detecting the presence of poisonous and volatile fumes and gas, and to determine oxygen deficiency in a given compartment. Individual items are listed on AEL #2-880044260 and in alphabetical order in this guide.

**CALIBRATION KIT - BIO-SYS
FOUR GAS ANALYZER
FOR MODEL 3210-LAP**

NSN 4240-LL-TRP-5533

WT. 4.7 lbs.

VOL. 810.0 in.³

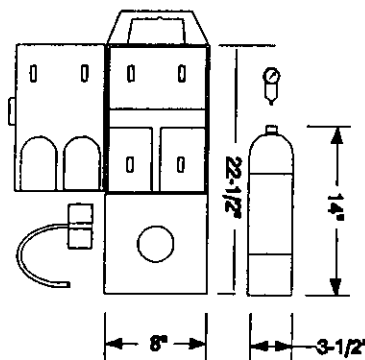

1

Helpful Hints:

Actual Inventory:

**FOUR GAS ANALYZER
INDICATOR
MODEL 3210-LAP**

NSN 4240-LL-TRP-8965

WT. 22.0 oz.

VOL. 53.6 in.³

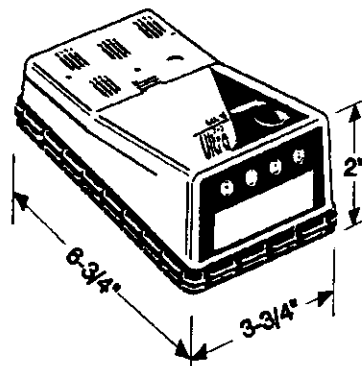

1

Helpful Hints: Carrying case is 19 lbs, 2,432 in.³.

Actual Inventory:

GAS FREE ENGINEER KIT

Quantity
Required

**OPERATIONAL TEST/CHECK KIT
FOR COMBUSTIBLE
GAS INDICATOR PORTABLE
NSN 6665-00-188-4542
FOR BACHARACH GN TYPE "E" II**

WT. 5.0 lbs.

VOL. 279.6 in.³

DELETE

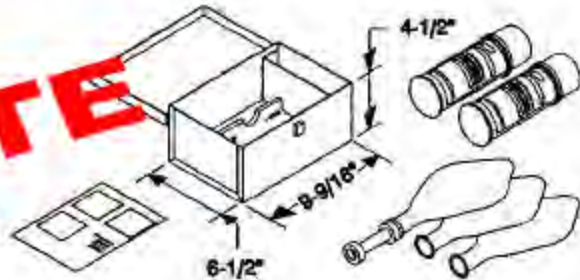

1

Helpful Hints: Utilize operational test/check kit that matches equipment manufacturer onboard. Test kit for the Bacharach GN Type "E" II Combustible Gas Indicator only, requires test gas acetylene P/N 51-2270.

Actual Inventory:

**DETECTOR KIT - GAS TOXIC
"DRAEGER" MOD 400**

NSN 6665-00-710-7815

WT. 3.0 lbs.

VOL. 253.8 in.³

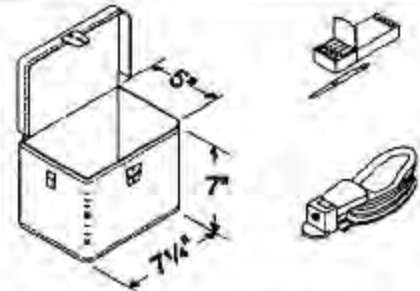

1

Helpful Hints:

This NSN provides stowage case and bellows pump. Tubes must be ordered separately. NSTM 074 Vol 3 provides guidance on gas free engineering. See AEL 2-870004169 for list of additional tubes.

Actual Inventory:

**INDICATOR - COMBUSTIBLE GAS
PORTABLE, GN TYPE "E" II
(AEL 2-870004050)**

NSN 6665-00-292-9945

WT. 6.0 lbs.

VOL. 105.0 in.³

DELETE



Helpful Hints: Utilize Combustible Gas Indicator onboard, Test Kit NSN: 9G 6665-01-188-4542. Requires Test Gas Acetylene P/N 51-2270.

Actual Inventory:

GAS FREE ENGINEER KIT

Quantity
Required

**INDICATOR - COMBUSTIBLE GAS
BACHARACH (MODEL 514)**

NSN 6665-00-294-8859

DELETE

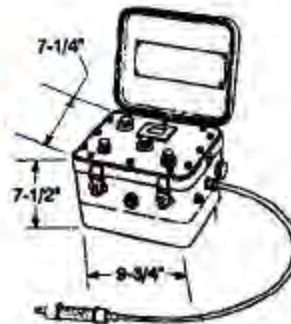

1

WT. 11.0 lbs.

VOL. 534.3 in.³ (indicator)

WT. 30.0 lbs.

VOL. 4,431.0 in.³ (indicator w/ carrying case)

Helpful Hints: Utilize Combustible Gas Indicator onboard. Bacharach Model 514 Combustible Gas Indicator comes with the test kit on initial issue. If there is a need to replace test kit, open purchase kit. Cal gases, methane P/N 51-2394, 9G 6830-01-370-8166 or hydrogen P/N 51-2395, 9G 6830-01-360-1866. Includes indicator, hydrogen cal. tank, 5 ft hose assy, regulator assy, O₂ cell assy, probe assy, carrying strap, drying tube, 12V DC charger cord, 120V charger cord, 230 VAC charger cord, sample line kit, 15 ft hose assy and methane cal tank.

Actual Inventory:

**INDICATOR - OXYGEN
MODEL 103**

NSN 6680-01-209-5449

WT. 0.7 lbs.

VOL. 17.2 in.³

DELETE

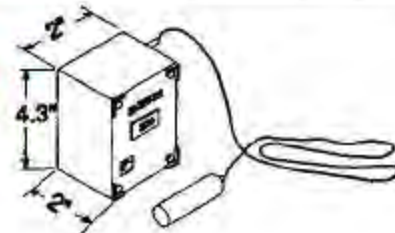

1

Helpful Hints: Utilize oxygen indicator onboard.

Actual Inventory:

**INDICATOR - OXYGEN/COMBUSTIBLE
(MODEL 260)**

NSN 6665-01-115-7666

WT. 7.5 lbs

VOL. 262.5 in.³

DELETE

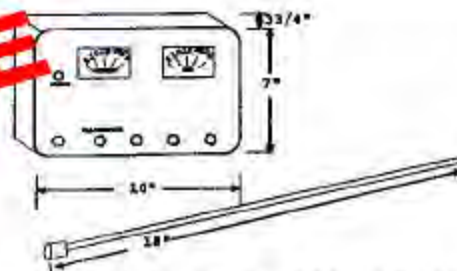

1

Helpful Hints: Utilize oxygen/combustible meter onboard. MSA Model 260, Part No. 449900. Cal Kit Model R - Part No. 466193, Penetane NSN 6665-01-297-1039. Charging cable included. Tube, 18" probe, line strap assy, carrying harness, sample line, regulator 1.5 L/M. Sample line 15 ft.

Actual Inventory:

GAS FREE ENGINEER KIT

Quantity
Required

TOOL BOX - PORTABLE
24" x 12" x 12"

DELETE

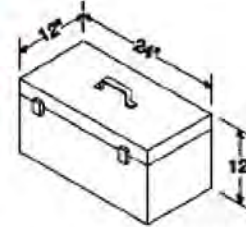

1

NSN 5140-00-226-9018

WT. 14.0 lbs.

VOL. 3,456.0 in³

Helpful Hints: Utilize existing tool box or substitute one of approximate size. Used for gas free engineer's equipment. Replace with color-coded photo-luminescent marked bag, provided as NAVSEA funds are available.

Actual Inventory:

TUBE -

- | | |
|---|---|
| <p>NSN 6665-00-769-0945
 NSN 6665-00-769-0949
 NSN 6665-01-102-9485
 NSN 6665-01-384-1508
 NSN 6665-00-769-0959
 NSN 6665-01-010-7959
 NSN 6665-01-010-7960
 NSN 6665-01-010-7961
 NSN 6665-01-010-7963
 NSN 6665-01-010-7965
 NSN 6665-01-010-7969
 (BOX OF 10)</p> | <p>CARBON DIOXIDE
 CARBON MONOXIDE
 ETHYLENE OXIDE
 HYDROCARBON 2
 HYDROCYANIC ACID
 HYDROCHLORIC
 HYDROGEN FLUORIDE
 HYDROGEN SULPHIDE
 NITROGEN DIOXIDE
 PHOSGENE
 VINYLCHLORIDE(BOX OF 10)</p> |
|---|---|

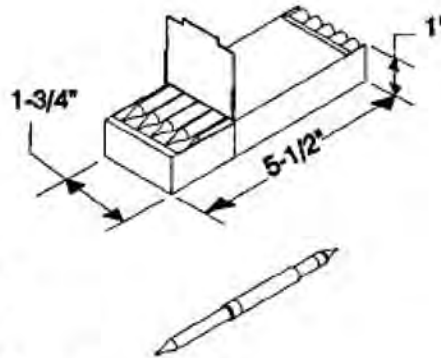

1 of
each
box

WT. 0.3 oz

VOL. 9.6 in³

Helpful Hints: NSN provides a box of 10 tubes per box. Utilize POP system to order Draeger tubes direct from manufacturer in Pittsburgh, PA. See NSTM 074 Vol 3 Appendix I for procedures and tube information. Order ethylene oxide tubes as required.

Actual Inventory:

INVESTIGATOR KIT

AEL Range: 2-880044262 to 4263

A laminated inventory list should be provided with this kit.

INVESTIGATOR KIT

Quantity
Required

KIT - INVESTIGATOR-DC

1H 0000-LL-CQA-2457

This kit identifies all equipment used for the function of performing the preliminary survey of a known or suspected damage/fire/flooding area. Individual items are listed on AEL #2-880044262 and in alphabetical order in this guide.

BAG-TOOL SACHEL -

NSN 5140-00-293-2379

WT. 3.9 lbs

VOL. 2,160.0 in³

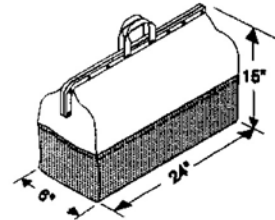

1

Helpful Hints: Utilize bag that's available (lineman or satchel). Not to exceed 18" in dia/width. Replace with color-coded photo-luminescent marked bag, MIL-B-43663, as NAVSEA funds are available.

Actual Inventory:

BELT - INVESTIGATORS

NSN 5140-00-529-1889

WT. 1.0 lbs.

VOL. 22.5 in³

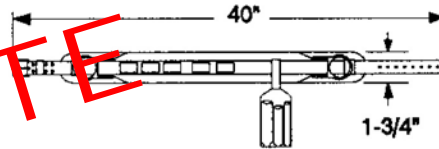

2

Helpful Hints: Select tools required for specific area in DCRS zone. Safety Belt allows for hands free movement on ladders. Exercise caution when personnel are below. Extra tools are to remain in tool-bag in DCRS. Retrieve items as required.

Actual Inventory:

FLASHLIGHT - WATERPROOF

NSN 6230-00-270-5418

WT. 3.0 oz

VOL. 43.1 in³

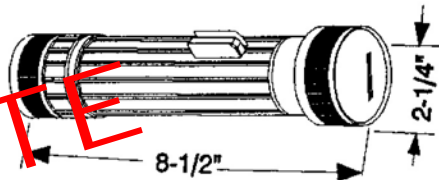

2

Helpful Hints: Without "D" cell batteries with 2 lamps, 1 spot and 1 diffusing. 2 filters, 1 blackout and 1 red lens.

Actual Inventory:

INVESTIGATOR KIT

Quantity
Required

MESSAGE BLANKS -
LOCALLY PREPARED

1HS0000-LL-CJA-1884

(PAD OF 100)

WT. 0.5 lbs

VOL. 21.0 in³

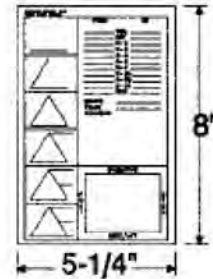

1

Helpful Hints: Locally prepared. Refer to NSTM 079 VOL 2, Practical
Damage Control, Appendix B

Actual Inventory:

PEN - BALL POINT BLACK

NSN 7520-00-935-7136

WT. 0.5 oz

VOL. 0.6 in³



1
doz

Helpful Hints:

Actual Inventory:

PP-GLOVES - RUBBER
7500 VOLT

NSN 8415-01-158-9450
(PAIR)

WT. 1.0 lb

VOL. 77.0 in³

DELETE

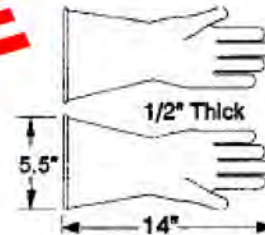

2
pr

Helpful Hints: Safety requirement.

Actual Inventory:

FLASHLIGHT - SABER

NSN 6230-01-281-3775

Helpful Hints: Uses 3 "C" cell batteries.



2

Actual Inventory:

INVESTIGATOR KIT

Quantity
Required

PP-GLOVES - SHELL ELEC

NSN 8415-00-264-3618
(PAIR)

WT. 1.5 lbs

VOL. 84.0 in³



2

Helpful Hints: Safety requirement.

DELETE

Actual Inventory:

PP-GLOVES - FIREMAN

1HM0000-LL-CQA-2201 SELECT SIZE
NSN 8415-01-421-1368 SIZE SML
NSN 8415-01-421-1371 SIZE MED
NSN 8415-01-421-1373 SIZE LRG
NSN 8415-01-421-1375 SIZE X-LRG
NSN 8415-01-421-1376 SIZE XX-LRG
(PAIR)

WT. 2.0 lbs.

VOL. 108.0 in³

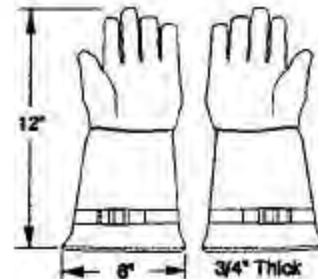

1

Helpful Hints: Prior to ordering Fireman's Gloves, verify NSN. Procure IAW MIL-G-24934 and National Fire Protection Association (NFPA) standards.

Actual Inventory:

TAPE - MEAS SOUNDING
50 FT

NSN 5120-00-221-1886

WT. 2.0 lbs.

VOL. 69.5 in³

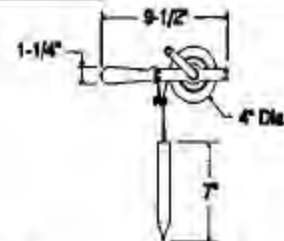

2

Helpful Hints: Substitute 75 ft. sounding tape NSN 5210-00-221-1887.

Actual Inventory:

INVESTIGATOR KIT

Quantity
Required

WRENCH - CRESCENT
15" LONG - ADJUSTABLE TO 1.698 IN.
STEEL

NSN 5120-00-423-6728

WT. 4.0 lbs.

VOL. 52.9 in.³

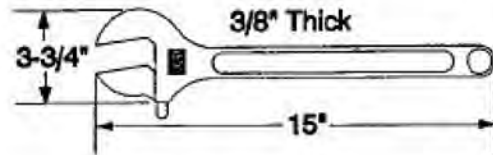

1

Helpful Hints:

Actual Inventory:

WRENCH - DOGGING
1" x 11" GALV PIPE

1HS0000-LL-CJA-1883

1HS0000-LL-CJ7-5887

WT. 0.7 lbs

VOL. 8.6 in³

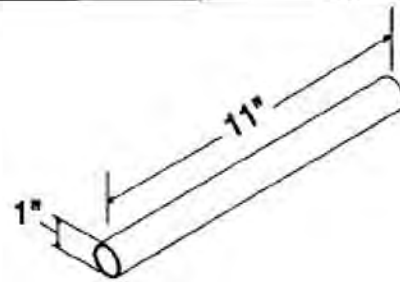

1

Helpful Hints:

Actual Inventory:

WRENCH - SOCKET 1/2", 3/8", 3/4" AND 1" TEE HNDL

NSN 5120-00-227-7387 SIZE 3/4"

WT. 0.5 lbs AVG

VOL. 21.6 in³ AVG

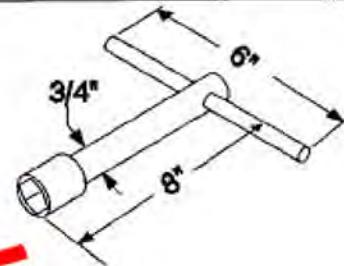

1

Helpful Hints:

Actual Inventory:

BATTERIES - C CELL

NSN 6135-00-935-7846

6

Helpful Hints: Used for Saber Light

Actual Inventory:

DELETE

INVESTIGATOR KIT

Quantity
Required

CHALK - CARPENTER'S WHITE

NSN 7510-00-272-9256
(BOX)

WT. 10.0 oz

VOL. 105.0 in³

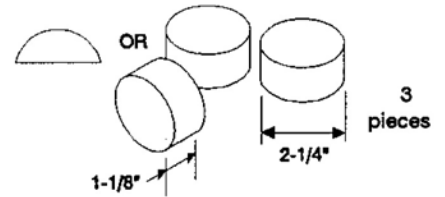

Helpful Hints: Provide 3 pieces of chalk from box to make up kit.

Actual Inventory:

PASTE - WATER IND

NSN 6850-00-001-4194

WT. 1.0 oz

VOL. 28.3 in³

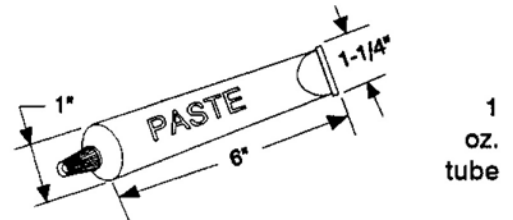

Helpful Hints: Shelf life item.

Actual Inventory:

PENCIL - CHINA MARKER BLACK

NSN 7510-00-240-1526

WT. 0.5 oz

VOL. 0.6 in³

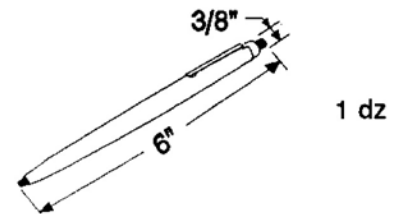

Helpful Hints:

Actual Inventory:

RAGS - COTTON

NSN 7920-00-205-1711
(BALE)

WT. 50.0 lbs.

VOL. 13,824.0 in³

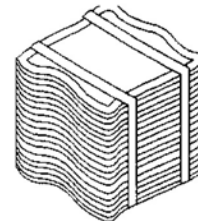

Helpful Hints: Provide 3 rags from the bale to make up kit. Stow bale in DCRS or work center storeroom.

Actual Inventory:

INVESTIGATOR KIT

Quantity
Required

**SOUNDING LIST -
LOCALLY PREPARED**

1HM0000-LL-CQA-0098

WT. 0.2 lbs.

VOL. 23.8 in³

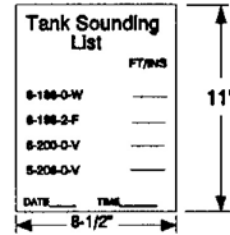

1

Helpful Hints: Sounding list should not be confused with the daily liquid load list. Sounding list will give depths and the amount of liquid held in tanks and voids when flooded/filled.

Actual Inventory:

THIEF SAMPLER - (BOTTOM)

1HS0000-LL-CJ7-5896

WT. 3.0 lbs

VOL. 8.2 in³

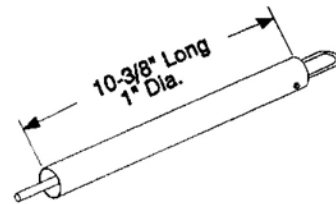

1

Helpful Hints:

Actual Inventory:

**WRENCH SOUNDING CAP -
(SIZE AS REQUIRED)**

1HM0000-LL-CQA-0099

WT. 1.5 lbs

VOL. 48.0 in³

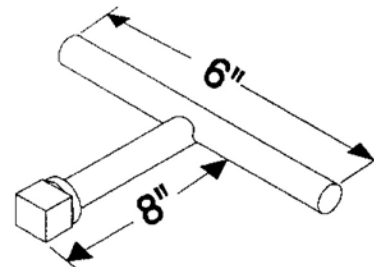

1

Helpful Hints:

Fabricate locally. Sounding tube wrench will be sized according to the specific ship. If more than one size is required, all sizes will be provided in the kit.

Actual Inventory:

**DELETE
This Kit**

LOW PRESSURE BOUNDARY COOLING KIT

AEL Range: 2-880044264 to 4265

A laminated inventory list should be provided with this kit.

L.P. BOUNDARY COOLING KIT

Quantity
Required

L.P. BOUNDARY COOLING - DC

1H 0000-LL-COA-2458

This kit identifies all equipment used for the function of providing cooling water to fire boundaries. Individual items are listed on AEL #2-880044264 and in alphabetical order in this guide. This kit will be fleet outfitted as funds are available.

HOSE - ASSY

1" x 50' NPSH

NSN 4210-00-542-3480

WT. 25.0 lbs.

VOL. 1,772.0 in.³

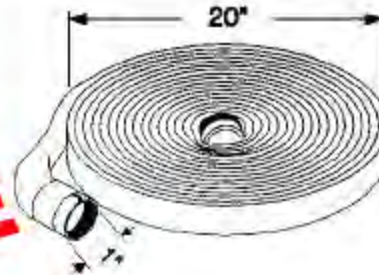

Helpful Hints:

Actual Inventory:

NOZZLE - FIREHOSE, WATER

1" NPSH FEMALE CONNECTOR

17-20 GPM, WILCO MODEL HH-1-L

NSN 4210-00-085-2291

WT. 1.0 lbs

VOL. 14.3 in.³

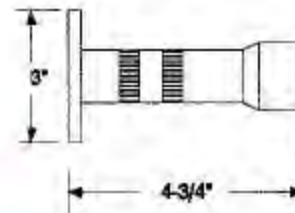

Helpful Hints:

Actual Inventory:

REDUCER - HOSE

1-1/2" to 1" NPSH MALE

NSN 4210-00-294-2648

WT. 1.5 lbs

VOL. 18.0 in.³

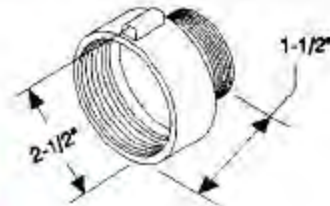

Helpful Hints:

Actual Inventory:

MONITORING TEAM KIT

AEL Range: 2-880044266 to 4267

A laminated inventory list should be provided with this kit.

MONITORING TEAM KIT

Quantity
Required

KIT - MONITORING TEAM-DC

1H 0000-LL-CQA-2459

This kit identifies all equipment used for the function of providing CBR surveys in order to isolate CBR boundaries. Individual items are listed on AEL #2-880044266 and in alphabetical order in this guide.

BAG, LINEMAN TOOL -

NSN 5140-00-288-7763

WT. 3.1 lbs

VOL. 594.0 in³

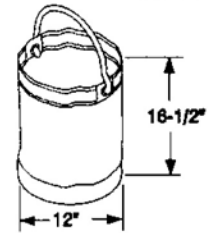

1

Helpful Hints: Replacement item. Utilize bag for small items.

Actual Inventory:

CHALK - MARKING

NSN 7510-00-282-6924 ASSORTMENT

NSN 7510-00-223-6706 WHITE

(BOX)

WT. 8.0 oz

VOL. 28.0 in³

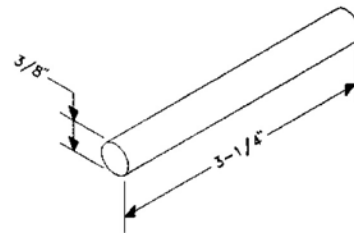

1

Helpful Hints:

Actual Inventory:

MESSAGE BLANKS -

1HS0000-LL-CJA-1884

(PAD OF 100)

WT. 0.5 lbs

VOL. 21.0 in³

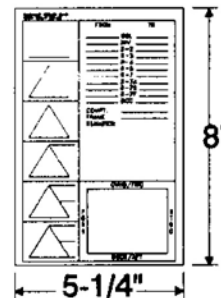

1

Helpful Hints: Locally prepared. Refer to NSTM 079 VOL 2, Practical Damage Control, Appendix B.

Actual Inventory:

MONITORING TEAM KIT

Quantity
Required

PENCIL - CHINA MARKER BLACK

NSN 7510-00-240-1526

WT. 0.5 oz

VOL. 0.6 in³

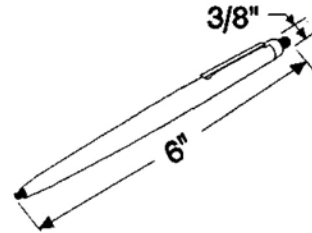

1
doz

Helpful Hints:

Actual Inventory:

SCISSORS -

NSN 6515-00-935-7138

WT. 0.6 lbs.

VOL. 9.4 in³

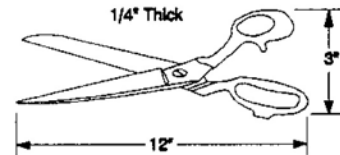

2
pr

Helpful Hints: Used to cut twine in monitoring operations.

Actual Inventory:

SIGN - BIOLOGICAL

1HM0000-LL-CQA-0092

(PACKAGE OF 10)

WT. 1.0 lbs.

VOL. 135.0 in³

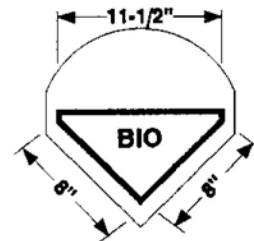

10

Helpful Hints: Signs to be manufactured NSTM 470 and NSTM 070. These signs are also available from the 3-M Co.

Actual Inventory:

MONITORING TEAM KIT

Quantity
Required

SIGN - CHEMICAL

1HM0000-LL-CQA-0093
(PACKAGE OF 10)
WT. 1.0 lbs.

VOL. 135.0 in³

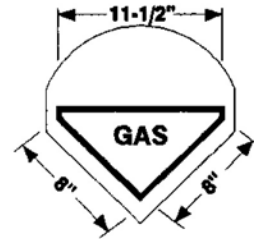

10

Helpful Hints: Signs to be manufactured IAW NSTM 470 and NSTM 070. These signs are also available from the 3-M Co.

Actual Inventory:

SIGN - RADIOLOGICAL

1HM0000-LL-CQA-0094
(PACKAGE OF 10)
WT. 1.0 lbs.

VOL. 135.0 in³

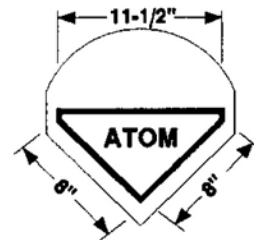

10

Helpful Hints: Signs to be manufactured IAW NSTM 470 and NSTM 070. These signs are also available from the 3-M Co.

Actual Inventory:

SIGN - UNEXPLODED MUNITION

1HM0000-LL-CQA-2766
(PACKAGE OF 10)
WT. 1.0 lbs.

VOL. 135.0 in³

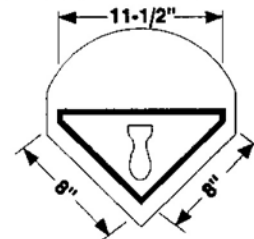

10

Helpful Hints: Signs to be manufactured IAW NSTM 470 and NSTM 070. These signs are also available from the 3-M Co.

Actual Inventory:

MONITORING TEAM KIT

Quantity
Required

TIMER - OBA

NSN 4240-01-049-1024

WT. 0.2 lbs.

VOL. 16.0 in³

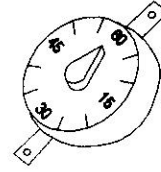

1
each

Helpful Hints:

Actual Inventory:

TWINE - HEMP FIBROUS

NSN 4020-00-231-5870

WT. 1.0 lb

VOL. 64.0 in³

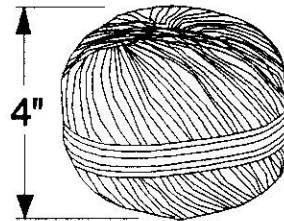

1 lb

Helpful Hints:

For securing signs indicating contaminated area. Attach to signs at appropriate MOPP level for ease of use.

Actual Inventory:

PIPE PATCHING KIT

AEL Range: 2-880044268 to 4269

A laminated inventory list should be provided with this kit.

PIPE PATCHING KIT

Quantity
Required

KIT - PIPE PATCHING-DC

1HM0000-LL-CQA-0095

This kit identifies all equipment used for the function of providing emergency pipe repair on L.P. systems. Individual items are listed on AEL #2-880044268 and in alphabetical order in this guide.

BAG-KIT -

NSN 8460-00-606-8366

WT. 2.3 lbs

VOL. 5,804.5 in³

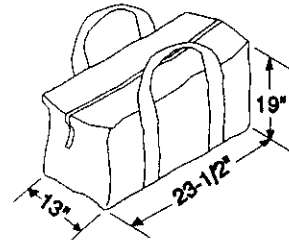

2
each

Helpful Hints: Replacement item. Utilize bag of equal size. If bag is substitute, it must fit through escape scuttle 18" in diameter. Stow all plugs/wedges, oakum, duck cloth, marlin and rubber sheet in 1st bag and stencil in 1" black letters "PIPE PATCHING MATERIALS". In 2nd bag stow all tools and stencil in 1" black letters "PIPE PATCHING TOOLS".

Actual Inventory:

BLADE - HACKSAW 12"

Teeth Size
(24 Teeth per inch)

NSN 5110-00-277-4590 = 12" blade

WT. 0.5 lbs.

VOL. 3.8 in³

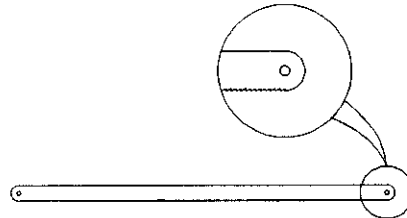

1
bdl

Helpful Hints: 10 blades per box.

Actual Inventory:

CANVAS - DUCK CLOTH
36" WIDE ROLL - 6' LONG

NSN 8305-01-198-9806

WT. 3.5 lbs.

VOL. 522.0 in³

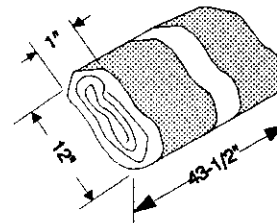

2
yards

Helpful Hints:

Actual Inventory:

PIPE PATCHING KIT

Quantity
Required

CHISEL - WOOD 1" X 6-1/4" BLADE

NSN 5110-00-840-5419

WT. 3.1 oz

VOL. 6.1 in.³

DELETE

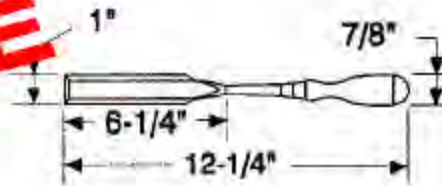

1

Helpful Hints: Recommend providing protective cover over cutting edge.

Actual Inventory:

FRAME - HAND HACKSAW
PISTOL GRIP, ADJUSTABLE FOR 10" TO
12" BLADES.

NSN 5110-00-289-9657

WT. 2.4 lbs.

VOL. 90.2 in.³

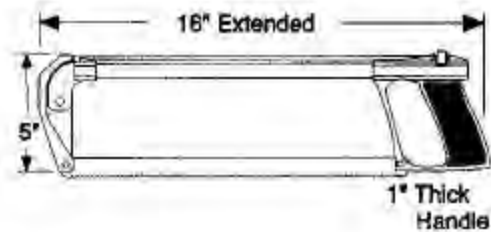

1

Helpful Hints: Recommend providing protective cover for saw blade.

Actual Inventory:

GLOVES - CUT RESISTANT

1HS0000-LL-CQA-4568

NSN 4220-01-397-7348 - sz med

4220-01-397-7349 - sz lg

WT. 0.5 lbs.

VOL. 56.0 in.³



2 pr
ea
size

Helpful Hints: Gloves provide protection when handling sharp objects.

Actual Inventory:

PIPE PATCHING KIT

Quantity
Required

**HAMMER - BALLPEEN
MACHINIST 2 LB.
16" HANDLE (HICKORY)**

NSN 5120-00-061-8546

WT. 2.5 lbs

VOL. 76.0 in³

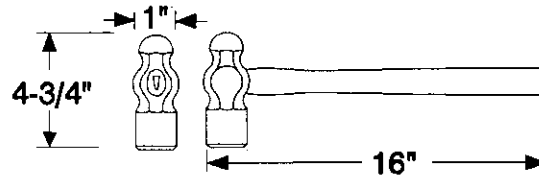

1

Helpful Hints: Used to drive wedges in pipe patches and to peen down ears on buckles in banding installation on pipes.

Actual Inventory:

**HATCHET - HALF TYPE C
14" HANDLE-HICKORY
HEAD WEIGHT 18 TO 26 OZ.
NSN 5110-00-228-3161**

WT. 3.1-3.6 lbs

VOL. 112.5 in³

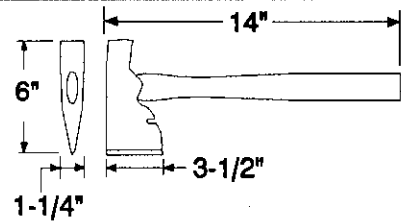

1

Helpful Hints: Recommend providing protective cover.

Actual Inventory:

MARLINE-TAR - 2 PLY

NSN 4020-00-240-2185

WT. 20 lbs.

VOL. 1,728.0 in³

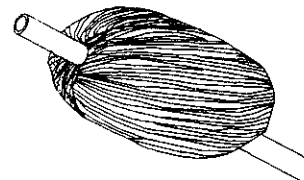

1
coil

Helpful Hints: Comes in box of 20 @ 5 lbs. Cut 131 ft. of marlin from coil or ball. Wrap around wooden dowel (12" broom handle stock) and stow in bag to reduce weight/bulk of kit bag. Start 1-1/2" in from end, wrap marlin tight.

Actual Inventory:

PIPE PATCHING KIT

Quantity
Required

OAKUM SPUN TAR -

NSN 5330-00-191-5679

WT. 1.0 lbs. VOL. 448.0 in³



1
lb.

Helpful Hints: Provide 1 lb. of oakum in bag and stow in a protective package. Place the remainder in a box in DCRS to reduce the weight and bulk of the kit bag. Oakum supplied in either 5 lb. or 50 lb. boxes.

Actual Inventory:

PATCH - EMERGENCY WATER ACTIVATED

NSN 5330-01-242-6186 - 2" WIDE
5330-01-253-9953 - 4" WIDE

WT. 0.3 lbs. VOL. 20.0 in³

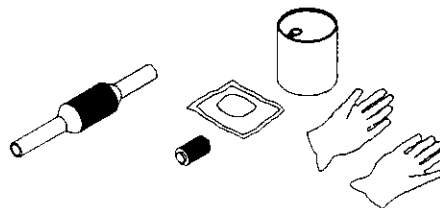

1
each
size

Helpful Hints: Provide dry stowage location. Prevent puncture of package.

Actual Inventory:

PLUG - WOOD, TAPERED
1" x 0" DIA x 3"

NSN 5510-00-260-8953

WT. 1.0 oz VOL. 0.7 in³

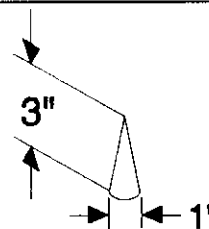

2

Helpful Hints: Softwood, Douglas Fir.

Actual Inventory:

PIPE PATCHING KIT

Quantity
Required

PLUG - WOOD, TAPERED
2" x 0" DIA x 4"

NSN 5510-00-260-8958

WT. 0.1 lbs. **VOL.** 4.2 in³

Helpful Hints: Softwood, Douglas Fir.

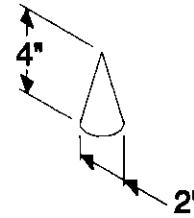

2

Actual Inventory:

PLUG - WOOD, TAPERED
3" x 0" DIA x 8"

NSN 5510-00-260-8962

WT. 0.4 lbs. **VOL.** 18.8 in³

Helpful Hints: Softwood, Douglas Fir.

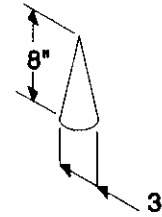

2

Actual Inventory:

RUBBER SHEET - SOLID
2 SHEETS 1/4" X 36" X 36"

NSN 5330-00-179-0052

WT. 4.0 lbs. **VOL.** 576.0 in³

Helpful Hints: Used to provide gasket for pipe patches and strongbacks in banding kit.

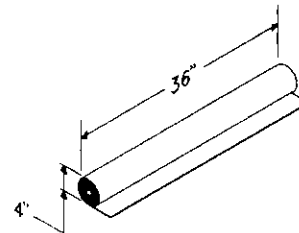

2

Actual Inventory:

PIPE PATCHING KIT

Quantity
Required

SAW - 18"
METAL CUTTING EDGE
15 POINTS PER INCH

NOTE: THIS SAW IS SHAPED LIKE
A WOOD SAW BUT HAS TEETH
SIMILAR TO A HACKSAW FOR
USE IN METAL CUTTING.



1

NSN 5110-00-221-0235

WT. 2.0 lbs.

VOL. 117.0 in.³

DELETE

Helpful Hints: Recommend providing cover for saw teeth (Split fire hose).

Actual Inventory:

SHEARS - TAILOR 12"

NSN 5110-00-223-6370

WT. 0.6 lbs.

VOL. 9.4 in.³

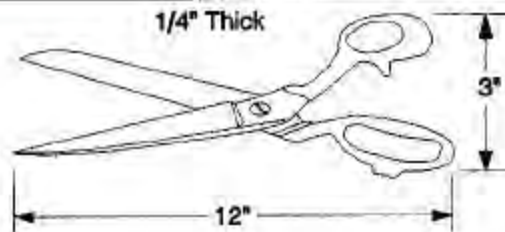

1

Helpful Hints:

Actual Inventory:

WEDGES - WOOD
2" x 2" x 8"

NSN 5510-00-268-3479

WT. 0.4 lbs

VOL. 16.0 in.³

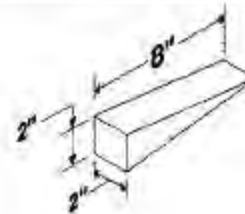

2

Helpful Hints: Softwood, Douglas Fir.

Actual Inventory:

PIPE PATCHING KIT

Quantity
Required

WEDGES - WOOD
3" x 3" X 12"

NSN 5510-00-268-3481

WT. 1.2 lbs

VOL. 54.0 in³

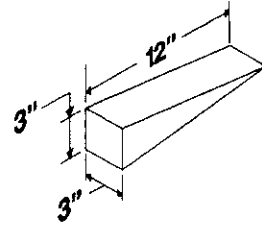

2

Helpful Hints: Softwood, Douglas Fir.

Actual Inventory:

WEDGES - WOOD
3" x 6" x 12"

NSN 5510-00-268-3482

WT. 2.5 lbs

VOL. 108.0 in³

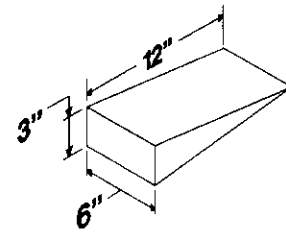

2

Helpful Hints: Softwood, Douglas Fir.

Actual Inventory:

PORTABLE PUMP KIT

Quantity
Required

**HOSE ASSEMBLY - 4" x 50 FT.
NON-METALLIC**

NSN 4210-01-220-6648

WT. 60.0 lbs. VOL. 4,064.0 in³

Helpful Hints:

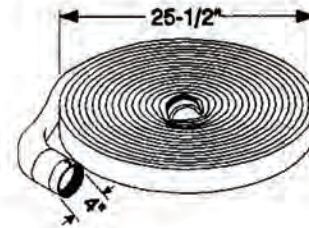

1

Actual Inventory:

**HOSE ASSEMBLY - HARD RUBBER
SUCTION, 3" x 10 FT.**

NSN 4210-00-725-9234

WT. 30.0 lbs. VOL. 3,000.0 in³

Helpful Hints:

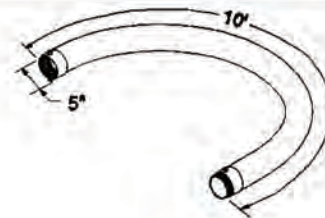

1

Actual Inventory:

**HOSE ASSEMBLY - NON-METALLIC
JUMPER DISCHARGE HOSE FOR P-250
TO WYE-GATE/SIAMESE CONNECTION**

NSN 4210-01-273-4727

WT. 6.8 lbs VOL. 607.5 in³

Helpful Hints: 2-1/2" male/female NHT couplings.

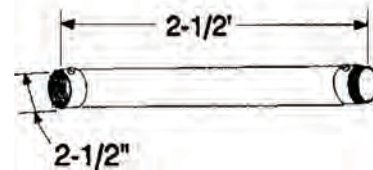

1

Actual Inventory:

**HOSE ASSEMBLY - RUBBER EXH. HOSE, BLACK
2" x 20 FT.**

NSN 4210-00-776-0657

WT. 23.0 lbs. VOL. 3,000.0 in³

Helpful Hints:

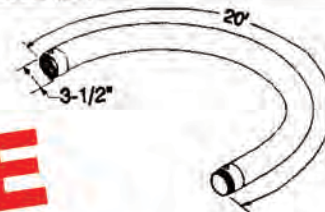

1

Actual Inventory:

DELETE

PORTABLE PUMP KIT

Quantity
Required

KIT - PORTABLE PUMP
ACCESSORIES-DC

1H 0000-LL-CQA-2460

This kit identifies all equipment used for the function of providing accessories to the P-250 (MOD 1 & MOD 2) and P-100 pumps to function as a dewatering/fire fighting pump. Individual items are listed on AEL #2-880044270 and in alphabetical order in this guide.

AURAL PROTECTOR, HEADSET -

NSN 4240-00-759-3290

WT. 0.6 lbs VOL. 108.0 in³



5

Helpful Hints:

Actual Inventory:

BAG, LINEMAN TOOL -

NSN 5140-00-288-7763

WT. 3.1 lbs VOL. 594.0 in³

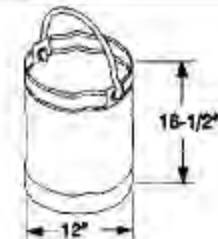

1

Helpful Hints: Stow small pilferable items of equipment.

Actual Inventory:

CAN - FUEL
P-250 (MOD 1 or MOD 2)

NSN 2910-01-222-7294

WT. 45.0 lbs. VOL. 2,340.2 in³

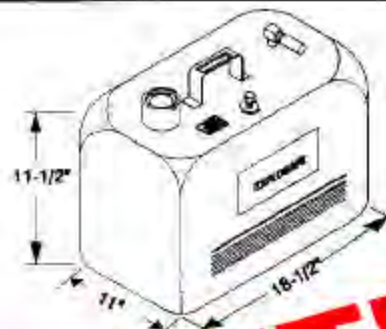

1

Helpful Hints:

Actual Inventory:

DELETE

PORTABLE PUMP KIT

Quantity
Required

CONNECTION - TRI GATE

2-1/2" INLET x TWO 1-1/2" OUTLETS X
ONE 2-1/2" OUTLET

NSN 4210-01-038-6001

WT. 15.3 lbs

VOL. 425.5 in³

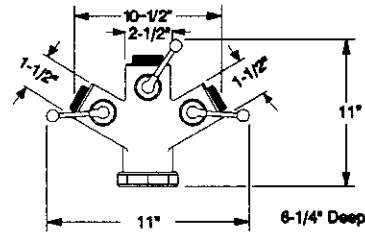

1

Helpful Hints: To protect male connectors flush and coat with silicone after use.

Actual Inventory:

EDUCTOR - PERI-JET

2-1/2" INLET x 4" OUTLET

NSN 4320-00-256-8206

WT. 35.0 lbs.

VOL. 2,720.0 in³

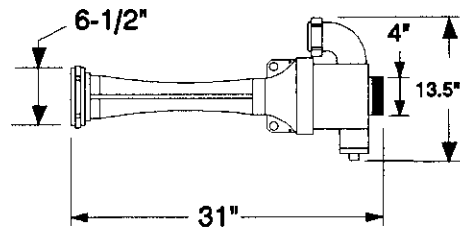

1

Helpful Hints: APL #740000002. Protect bottom 4" male connector threads. Flush after each use. Coat female and male threads with silicone after use.

Actual Inventory:

GASKET - WASHER, HOSE 2"

NSN 5330-00-239-1875

WT. 0.1 lbs

VOL. 0.5 in³

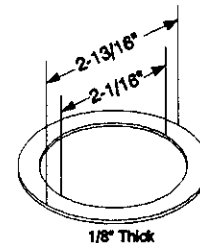

5

Helpful Hints: For 2" exhaust hose.

Actual Inventory:

PORTABLE PUMP KIT

Quantity
Required

GASKET/WASHER - 3" RUBBER

NSN 5330-00-239-1879

WT. 0.2 lbs

VOL. 1.4 in³

Helpful Hints: For 3" suction, female connector.

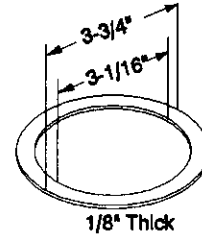

5

Actual Inventory:

GASKET/WASHER - 4" RUBBER

NSN 5310-00-239-1882

WT. 0.2 lbs

VOL. 1.5 in³

Helpful Hints: For eductor and 4" hose female connector.

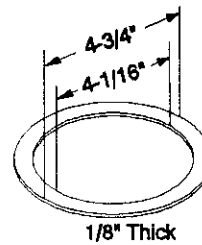

5

Actual Inventory:

GASKET/WASHER - 1-1/2" NON-METALLIC

NSN 5330-00-239-1873

WT. 0.1 lbs

VOL. 0.5 in³

Helpful Hints: For 1-1/2" fire hose.

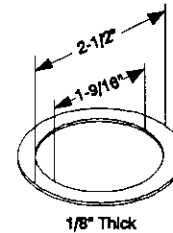

10

Actual Inventory:

GASKET/WASHER - 2-1/2" NON-METALLIC

NSN 5330-00-246-2914

WT. 0.1 lbs

VOL. 1.3 in³

Helpful Hints: For 2-1/2" fire hose.

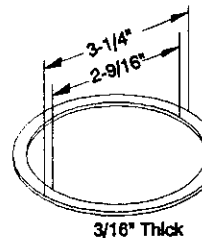

1

Actual Inventory:

PORTABLE PUMP KIT

Quantity
Required

**HOSE ASSEMBLY - 4" x 50 FT.
NON-METALLIC**

NSN 4210-01-220-6648

WT. 60.0 lbs. VOL. 4,064.0 in³

Helpful Hints:

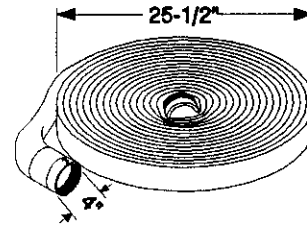

1

Actual Inventory:

**HOSE ASSEMBLY - HARD RUBBER
SUCTION, 3" x 10 FT.**

NSN 4210-00-725-9234

WT. 30.0 lbs. VOL. 3,000.0 in³

Helpful Hints:

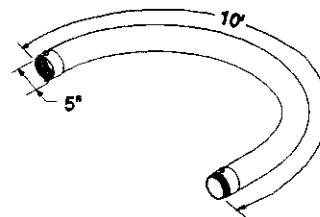

1

Actual Inventory:

**HOSE ASSEMBLY - NON-METALLIC
JUMPER DISCHARGE HOSE FOR P-250
TO WYE-GATE/SIAMESE CONNECTION**

NSN 4210-01-273-4727

WT. 6.8 lbs VOL. 607.5 in³

Helpful Hints: 2-1/2" male/female NHT couplings.

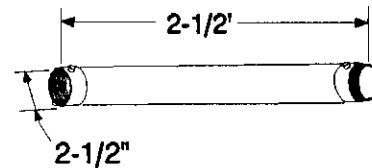

1

Actual Inventory:

**HOSE ASSEMBLY - RUBBER EXH. HOSE, BLACK
2" x 20 FT.**

NSN 4210-00-776-0657

WT. 23.0 lbs. VOL. 2,940.0 in³

Helpful Hints:

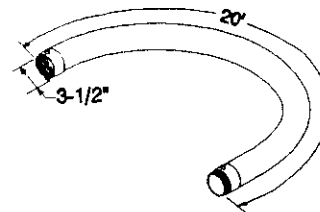

1

Actual Inventory:

PORTABLE PUMP KIT

Quantity
Required

HOSE - 1-1/2" x 50 FT.
NON-METALLIC

NSN 4210-01-131-0249

WT. 25.0 lbs.

VOL. 1,772.0 in.³

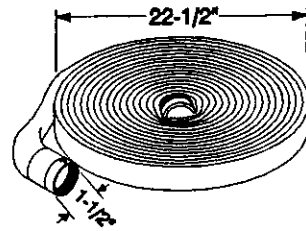

1

Helpful Hints:

Actual Inventory:

HOSE - 2-1/2" x 50 FT.
NON-METALLIC

NSN 4210-01-131-0247

WT. 35.0 lbs.

VOL. 2,890.0 in.³

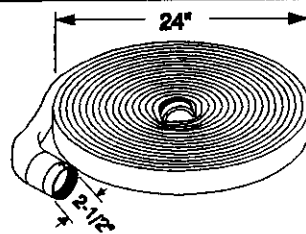

2

Helpful Hints:

Actual Inventory:

PUMP - P-100

NSN 6Y 4320-01-387-2869

WT. 165.0 bs

VOL. 12,091 in.³

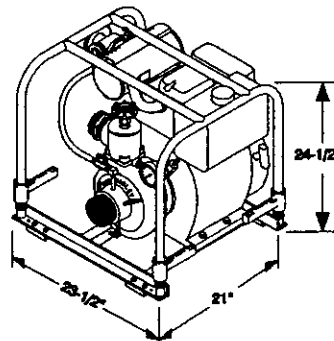

1

Helpful Hints:

Two each 2" x 10' suction hose provided with pump on initial issue.

Actual Inventory:

PORTABLE PUMP KIT

Quantity
Required

PUMP - P-250 MOD 1

NSN 4320-01-186-3377

WT. 155.0 lbs

VOL. 10,080.0 in³

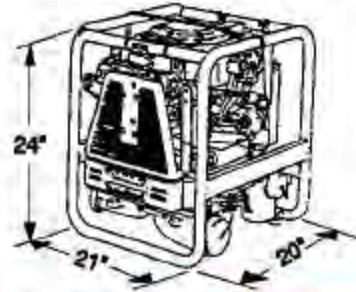

1

Helpful Hints: APL - 2-470004085 P-250 (mod 1) allowance
APL #017600005 P-250 unit repair parts (mod 1)
APL #017600006 P-250 pump end repair parts (mod 1)
APL #668200001 P-250 engine repair parts (mod 1)
APL #47000401516 P-250 accessories / eductor

DELETE

Actual Inventory:

REDUCER - HOSE

4" (M) TO 3" (F)

USE WITH P-250/EDUCTOR

NSN 4730-00-618-8593

WT. 11.0 lbs.

VOL. 132.1 in.³

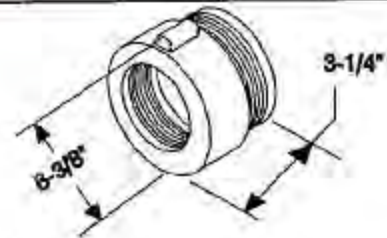

1

Helpful Hints:

Actual Inventory:

REDUCER - HOSE

4" (F) TO 3" (M)

NSN 4210-00-618-8592

WT. 11.0 lbs

VOL. 132.1 in.³

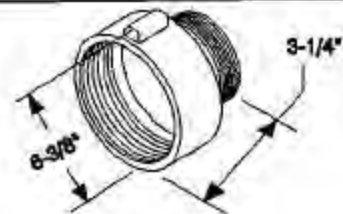

Helpful Hints:

Actual Inventory:

PORTABLE PUMP KIT

Quantity
Required

**VALVE - FOOT/STRAINER
FOR PUMP**

NSN 4820-01-540-2381

WT. 12.5 lbs

VOL. 312.3 in³

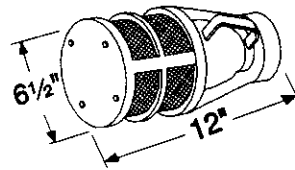

1

Helpful Hints:

Actual Inventory:

**WRENCH - SPANNER
ADJUSTABLE HOOK WITH FIXED PIVOT
RANGE FROM 2" TO 4-3/4"**

NSN 5120-00-277-9076

WT. 2.0 lbs.

VOL. 6.7 in³

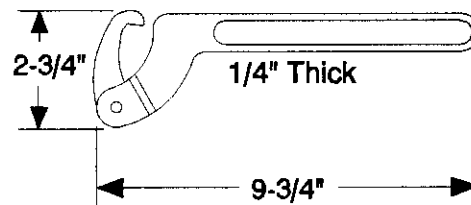

2

Helpful Hints:

Actual Inventory:

**WRENCH - SPANNER
3/4" TO 2"**

NSN 5120-00-288-6468

WT. 1.3 lbs

VOL. 3.0 in³

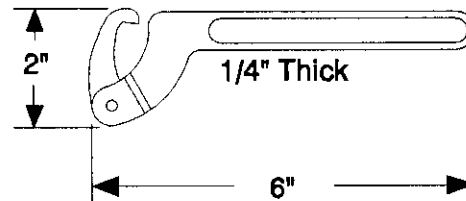

2

Helpful Hints:

Actual Inventory:

DELETE

This Kit

**PLASTIC PATCH / PIPE
REPAIR KIT**

**AEL Range: 2-880044271
2-880044222**

A laminated inventory list should be provided with this kit. This kit has been deleted as of Nov 95 for all ships except those whose allowances are given in AELs 2-880044200 and 44201.

PLASTIC PATCH / PIPE REPAIR KIT

Quantity
Required

KIT - PLASTIC PIPE PATCHING -
PLASTIC PATCH/PIPE REPAIR-DC

1H 0000-LL-CQA-2461

This kit identifies all equipment used for the function of providing emergency pipe repairs on various low and medium pressure systems. Individual items are listed on AEL #2-880044271 and in alphabetical order in this guide. Plastic patch kits should be kept together and carried to the scene as necessary to keep broken glass or spilled epoxy out of the bag.

BAG-TOOL SATCHEL -

NSN 5140-00-293-2379

WT. 3.9 lbs

VOL. 2,880.0 in³

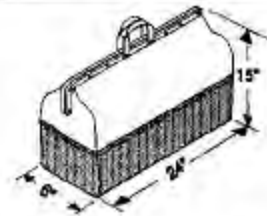

1

Helpful Hints: Replacement for cardboard shipping box. Utilize any bag available that will accommodate kit.

Actual Inventory:

PLASTIC PIPE PATCHING-CHALK LINE -
100 FT. REEL

NSN 4020-00-243-3152

WT. 0.5 lbs.

VOL. 5.5 in³



1

Helpful Hints:

Actual Inventory:

PLASTIC PIPE PATCHING - CLOTH -
X ABRASIVE

NSN 5350-00-192-5047

WT. 1.0 oz

VOL. 5.5 in³

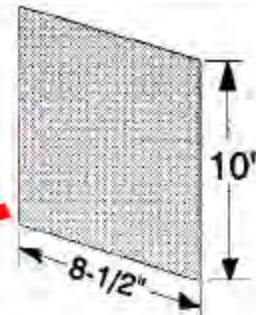

1

Helpful Hints:

Actual Inventory:

PLASTIC PATCH / PIPE REPAIR KIT

Quantity
Required

PLASTIC PIPE PATCHING - CLOTH -
GLASS WOVEN, ROVING

1HS000-LL-CE6-7634

WT. 10.0 oz

VOL. 144.0 in³

Helpful Hints:

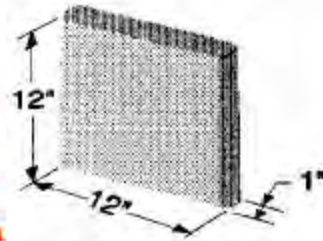

1

DELETE

Actual Inventory:

PLASTIC PIPE PATCHING-COVER - VOID

1HS0000-LL-CE6-7636

WT. 1.0 oz

VOL. 5.3 in³

Helpful Hints:

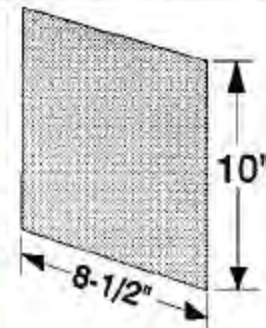

1

DELETE

Actual Inventory:

PLASTIC PIPE PATCHING-DEPRESSOR - TONGUE

NSN 6515-00-324-5500

WT. 1.0 oz.

VOL. 0.2 in³

Helpful Hints:

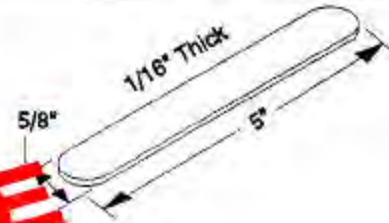

8

DELETE

Actual Inventory:

PLASTIC PIPE PATCHING-FILM -
POLYVINYLCHLORIDE

1HS0000-LL-CE6-7637

WT. 3.0 lbs.

VOL. 160.0 in³

Helpful Hints:



1

DELETE

Actual Inventory:

PLASTIC PATCH / PIPE REPAIR KIT

Quantity
Required

PLASTIC PIPE PATCHING-GLOVES -
POLYETHYLENE FILM
SIZE 10 OR 11 LARGE

1HS0000-LL-CE6-7638
(PAIR)

WT. 3.0 oz

VOL. 4.4 in³

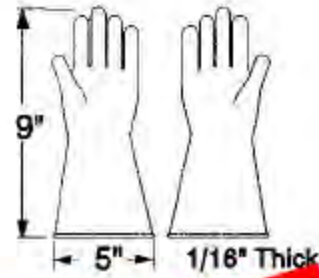

4

Helpful Hints:

DELETE
Actual Inventory:

PLASTIC PIPE PATCHING-HARDENER - PASTE

1HS0000-LL-CE6-7640

WT. 6.0 oz

VOL. 21.2 in³

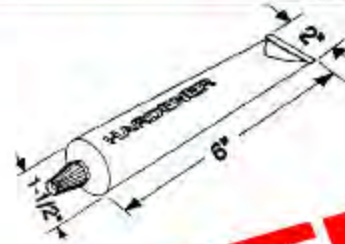

4

Helpful Hints:

DELETE
Actual Inventory:

PLASTIC PIPE PATCHING-HARDENER -
LIQUID

1HS0000-LL-CE6-7639

WT. 10.0 oz

VOL. 28.3 in³

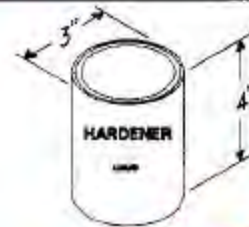

4

Helpful Hints:

DELETE
Actual Inventory:

PLASTIC PATCH / PIPE REPAIR KIT

Quantity
Required

KIT - PLASTIC PIPE PATCHING-
PLASTIC PATCH/PIPE REPAIR
(KIT #1)

NSN 4730-00-542-3359

This kit identifies all equipment used for the function of providing emergency pipe repairs on various low and medium pressure systems. Individual items are listed on AEL #2-880044271 and in alphabetical order in this guide.

Helpful Hints:

Actual Inventory:

1

DELETE

KIT - PLASTIC PIPE PATCHING -
PLASTIC PATCH/PIPE REPAIR
(KIT #2)

NSN 4730-00-542-3362

This kit identifies all equipment used for the function of providing emergency pipe repairs on low and medium pressure systems. Individual items are listed on AEL #2-880044271 and in alphabetical order in this guide.

Helpful Hints:

Actual Inventory:

1

DELETE

PLASTIC PIPE PATCHING-RESIN - LIQUID
400 GR PER CAN

1HS0000-LL-CE6-7641

WT. 14.0 oz

VOL. 36.0 in³

Helpful Hints:

Actual Inventory:

4

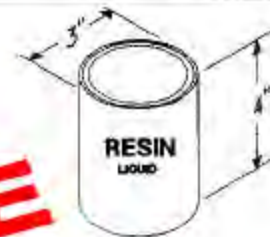

DELETE

PLASTIC PATCH / PIPE REPAIR KIT

Quantity
Required

PLASTIC PIPE PATCHING-RESIN - PASTE KIT 2
75 GR PER CAN

1HS0000-LL-CE6-7642

WT. 6.0 oz

VOL. 9.0 in³

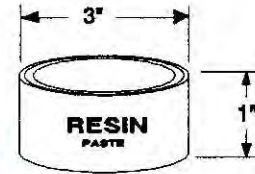

4

Helpful Hints:

DELETE

Actual Inventory:

PLASTIC PIPE PATCHING-SHEARS -

NSN 7520-00-161-6912

WT. 0.3 lbs

VOL. 5.6 in³

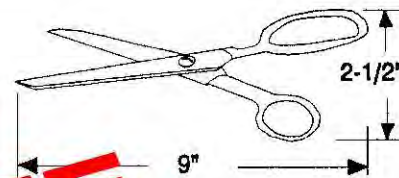

1

Helpful Hints:

DELETE

Actual Inventory:

PLASTIC PIPE PATCHING-SPATULA - WOOD

1HS0000-LL-CE6-7643

WT. 0.5 oz

VOL. 0.7 in³



2

Helpful Hints: Wooden paint spatula may be substituted.

DELETE

Actual Inventory:

PLUGGING KIT

AEL Range: 2-880044272 to 4273

A laminated inventory list should be provided with this kit.

PORTABLE EXOTHERMIC CUTTING UNIT (PECU) KIT

Quantity
Required

PECU-CLIP ON WELDER ADAPTER

NSN: 4240-01-250-8263

WT. 0.1 lbs.

VOL. in

DELETE

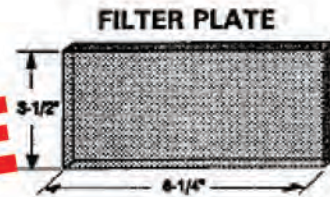

1

Helpful Hints: Fits OBA face piece. Adapter NSN 4240-01-250-8263 used Rayfoe filter plate, shade 6 NSN 4240-01-248-8021 and Lens NSN 4240-00-276-8941.

Actual Inventory:

PECU-MANUAL - OPERATORS

1H 0000-LL-CQA-2500

WT. 1.5 lbs.

VOL. 16 in³

DELETE

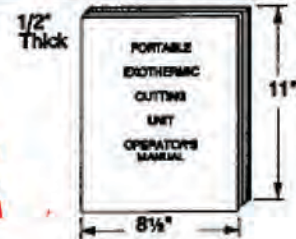

1

Helpful Hints: Stow with spare parts.

Actual Inventory:

PECU-CYLINDER - OXY 48 CUFT

NSN 6830-01-333-3151 (FULL BOTTLE)
 NSN 6830-01-333-3152 (REFILL GAS)
 NSN 8120-01-326-6750 (EMPTY BOTTLE)

WT. 30.0 lbs.

VOL. 538.0 in³



144
cu
ft

Helpful Hints: Three bottles are required in DCRS. (Two spares, one for immediate use.)

Actual Inventory:

PLUGGING KIT

Quantity
Required

**HAMMER - BALLPEEN
MACHINIST 2 LB.
16" HANDLE (HICKORY)**

NSN 5120-00-061-8546

WT. 2.5 lbs

VOL. 76.0 in³

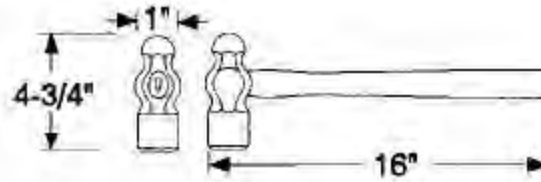

1

Helpful Hints:

Actual Inventory:

**HATCHET - HALF TYPE C
14" HANDLE-HICKORY
HEAD WEIGHT 18 TO 26 OZ.
NSN 5110-00-228-3161**

WT. 3.1-3.6 lbs

VOL. 112.5 in³

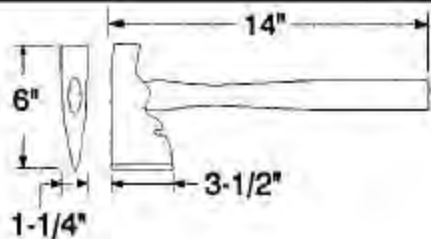

1

Helpful Hints: Recommend providing protective cover for blade.

Actual Inventory:

**HATCHET - LATHING
14" HANDLE (HICKORY)
2-1/4" CUTTING EDGE
HEAD WEIGHT 12 TO 17 OZ.
NSN 5110-00-223-5379**

WT. 2.1-2.6 lbs

VOL. 112.5 in³

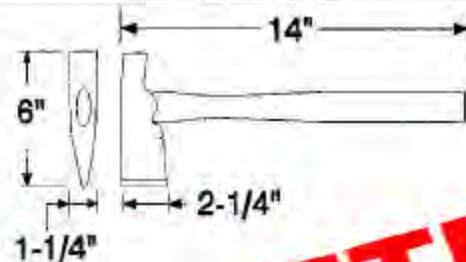

1

Helpful Hints: Recommend providing protective cover over blade.

Actual Inventory:

DELETE

PLUGGING KIT

Quantity
Required

MAUL - SHIP
5 LB., 32" HANDLE

NSN 5120-00-255-1476

WT. 6.7 lbs.

VOL. 542.5 in.³

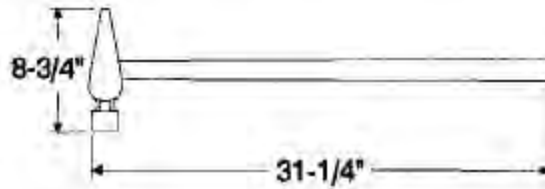

1

Helpful Hints:

Actual Inventory:

OAKUM SPUN TAR -

NSN 5330-00-191-5679

WT. 1.0 lbs.

VOL. 448.0 in.³



5
lbs.

Helpful Hints: Supply unit of issue is three rolls per box of 5 lbs. or 50 lbs. Provide 1 lb. in protective package. Stow the remainder in a box in DCRS to reduce the weight and bulk of the kit bag.

Actual Inventory:

PLUG - WOOD, TAPERED
10" x 7" DIA x 12"

NSN 5510-00-260-8949

WT. 15.9 lbs

VOL. 688.0 in.³

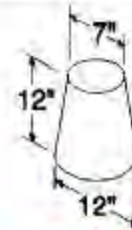

2

Helpful Hints: Softwood, Douglas Fir.

Actual Inventory:

DELETE

PLUGGING KIT

Quantity
Required

PLUG - WOOD, TAPERED
1" x 0" DIA x 3"

NSN 5510-00-260-8953

WT. 1.0 oz

VOL. 0.7 in³

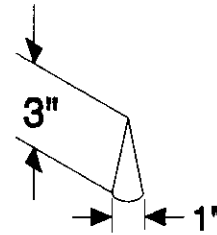

4

Helpful Hints: Softwood, Douglas Fir.

Actual Inventory:

PLUG - WOOD, TAPERED
2" x 0" DIA x 4"

NSN 5510-00-260-8958

WT. 0.1 lbs

VOL. 4.2 in³

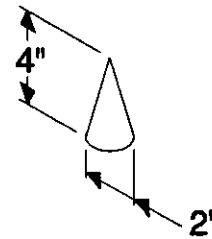

4

Helpful Hints: Softwood, Douglas Fir.

Actual Inventory:

PLUG - WOOD, TAPERED
3" x 0" DIA x 8"

NSN 5510-00-260-8962

WT. 0.4 lbs

VOL. 18.8 in³

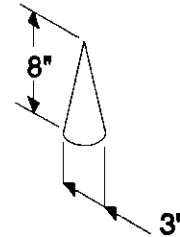

4

Helpful Hints: Softwood, Douglas Fir.

Actual Inventory:

PLUG - WOOD, TAPERED
5" x 1" DIA x 10"

NSN 5510-00-260-8966

WT. 1.9 lbs

VOL. 50.0 in³

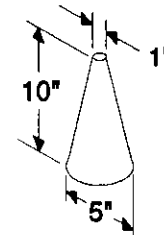

2

Helpful Hints: Softwood, Douglas Fir.

Actual Inventory:

PLUGGING KIT

Quantity
Required

PLUG - WOOD, TAPERED
7" x 3" DIA x 10"

NSN 5510-00-260-8969

WT. 4.8 lbs

VOL. 206.8 in³

Helpful Hints: Softwood, Douglas Fir



2

DELETE

Actual Inventory:

PLUG - WOOD, TAPERED
8" x 4" DIA x 10"

NSN 5510-00-260-8973

WT. 6.8 lbs

VOL. 293.2 in³

Helpful Hints: Softwood, Douglas Fir



2

DELETE

Actual Inventory:

SAW - HAND 26"
CROSS CUT - BEVEL FILED TEETH
SPRING SET

NSN 5110-00-596-0921

WT. 2.6 lbs.

VOL. 169.0 in³

Helpful Hints: Recommend providing protective cover (split fire hose). This saw is to be replaced by Stanley (15" 9pt), part No. 15-085, aggressive cut which cuts 50% faster. This item will be provided from NAVSEA as funds become available.

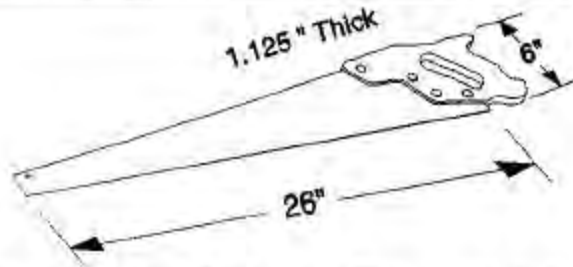

1

Actual Inventory:

SHEARS - TAILOR 12"

NSN 5110-00-223-6370

WT. 0.6 lbs.

VOL. 9.4 in³

Helpful Hints:



1

DELETE

Actual Inventory:

PLUGGING KIT

Quantity
Required

TOOL BOX - PORTABLE
7" x 7" x 16"

NSN 5140-00-315-2747

WT. 6.0 lbs

VOL. 784.0 in³

DELETE

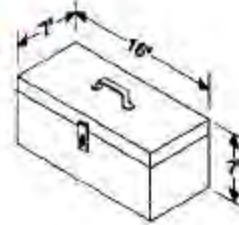

1

Helpful Hints: Utilize tool box of approximate size as substitute.

Actual Inventory:

WEDGE - WD
1-1/2" x 2" x 12"

NSN 5510-00-268-3475

WT. 0.4 lbs

VOL. 18.0 in³



6

Helpful Hints: Made of softwood.

Actual Inventory:

WEDGE - WD
1-1/2" x 3" x 12"

NSN 5510-00-268-3476

WT. 0.6 lbs

VOL. 27.0 in³

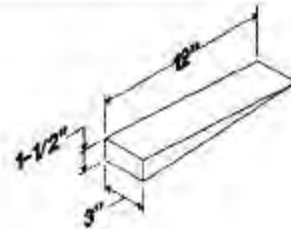

8

Helpful Hints: Made of softwood.

Actual Inventory:

WEDGE - WOOD
2-1/4" x 3" x 18"

NSN 5510-00-268-3477

WT. 1.4 lbs

VOL. 60.7 in³

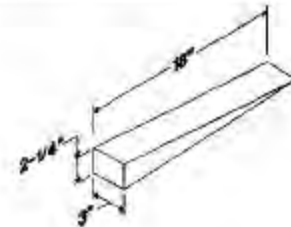

8

Helpful Hints: Made of softwood.

Actual Inventory:

PLUGGING KIT

Quantity
Required

WEDGES - WOOD
2" x 2" x 8"

NSN 5510-00-268-3479

WT. 0.4 lbs

VOL. 16.0 in³

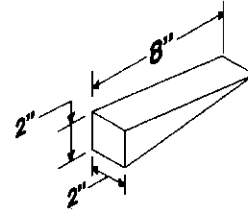

2

Helpful Hints: Softwood, Douglas Fir.

Actual Inventory:

WEDGES - WOOD
3" x 3" X 12"

NSN 5510-00-268-3461

WT. 1.2 lbs

VOL. 54.0 in³

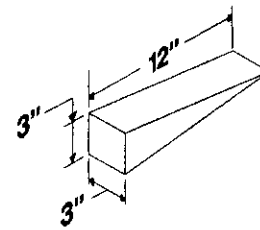

2

Helpful Hints: Softwood, Douglas Fir.

Actual Inventory:

WEDGES - WOOD
3" x 6" x 12"

NSN 5510-00-268-3482

WT. 2.5 lbs

VOL. 108.0 in³

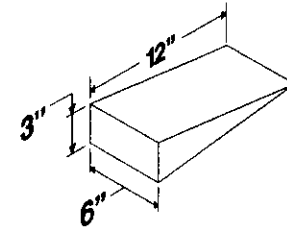

2

Helpful Hints: Softwood, Douglas Fir.

Actual Inventory:

**PORTABLE EXOTHERMIC
CUTTING UNIT (PECU)
KIT**

AEL Range: 2-880044274 to 4275

A laminated inventory list should be provided with this kit.

PORTABLE EXOTHERMIC CUTTING UNIT (PECU) KIT

Quantity
Required

KIT - PORTABLE EXOTHERMIC
CUTTING UNIT (PECU)-DC

NSN 4240-01-272-3841

The PECU will replace existing portable oxyacetylene cutting units on a one for one basis. The PECU will provide for more rapid access into areas of the ship where normal access is impaired for fire fighting operations, and to drain accumulated firefighting water from areas of the ship where the effects of the accumulated firefighting water will impair the ship's stability. The PECU utilizes expendable cutting rods which operate on the exothermic torch principle. This principle involves the use of oxygen which is combined with a fuel. In this case the fuel is a steel tube. The exothermic cutting rod is ignited when the oxygen passing through the iron rod comes in contact with a spark generated from a 12 volt DC battery powered igniter. This kit identifies all equipment used for the function of cutting through ferrous and non-ferrous wiring and other shipboard materials, particularly aircraft carrier flight decks. Individual items are listed on AEL #2-880044274 and in alphabetical order in this guide under the prefix "PECU".

Helpful Hints:

PECU - BATTERY - PKG WITH CHARGER

1H 0000-LL-CQA-2491

WT. 10.0 lbs. VOL. 200.7 in³

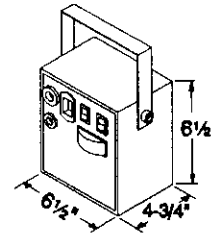

1

Helpful Hints:

Actual Inventory:

PECU - CABLE - BATTERY CHARGER

NSN 6150-01-323-2144

WT. 1.0 lbs. VOL. 196.0 in³

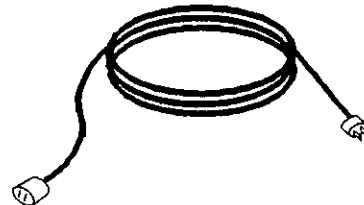

1

Helpful Hints:

Actual Inventory:

PORTABLE EXOTHERMIC CUTTING UNIT (PECU) KIT

Quantity
Required

PECU-CARRY CASE - ALUMINUM

1H 0000-LL-CQA-2488

WT. 12.0 lbs. VOL. 4,000.0 in³

Helpful Hints:

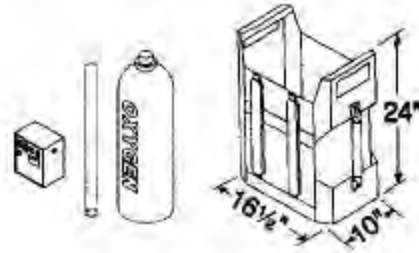

1

Actual Inventory:

PECU-CARRY CASE - AUX CYL

1H 0000-LL-CQA-2490

WT. 9.0 lbs. VOL. 3,564.0 in³

Helpful Hints:



1

Actual Inventory:

PECU-CARRY HARNESS - BACKPACK

1H 0000-LL-CQA-2489

WT. 3.0 lbs. VOL. 60.0 in³

Helpful Hints: Stowed with spare parts.

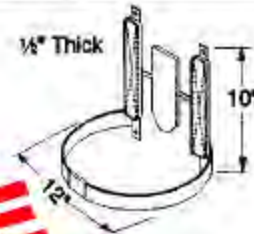

1

Actual Inventory:

DELETE

PORTABLE EXOTHERMIC CUTTING UNIT (PECU) KIT

Quantity
Required

CLOTH - SILICA WELDER'S - 1/8" THICK

NSN 8305-01-035-1058

WT. 6.0 lbs

VOL. 1,640.0 in³

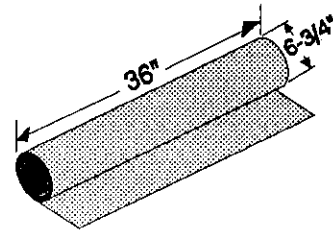

3

Helpful Hints: Stowed with spare parts.

Actual Inventory:

PECU-ELECTRODE CUTTING ROD -
1/4" x 22"

NSN 3449-01-325-7641

WT. 7.0 lbs.

VOL. 143.8 in³

(Shipping box 2 1/2" x 1 1/2" x 23"L)

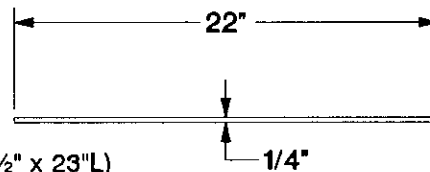

25
in
each
box

Helpful Hints: Box of 25. Only 1 box of 25 required.

Actual Inventory:

PECU-ELECTRODE CUTTING ROD -
3/8" x 36"

NSN 3449-01-325-7642

WT. 34.0 lbs.

VOL. 243.8 in³

(Shipping box 2 1/2" x 2 1/2" x 39"L)

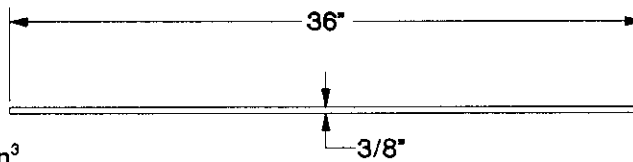

25
in
each
box

Helpful Hints: Box of 25. Only 1 box of 25 required.

Actual Inventory:

PORTABLE EXOTHERMIC CUTTING UNIT (PECU) KIT

Quantity
Required

PECU-GLOVES - WELDERS

1H 000-LL-CQA-2493 (SELECT SIZE)
NSN 8415-00-268-7860 SIZE MED
NSN 8415-00-268-7859 SIZE LRG

WT. 1.5 lbs

VOL. 74.2 in³



1
pair

Helpful Hints:

Actual Inventory:

PECU-GOGGLES - INDUSTRIAL

NSN 4240-00-203-3804

WT. 4.0 oz

VOL. 45.0 in³



1

Helpful Hints:

DELETE

Actual Inventory:

PECU-HOSE-EXTENSION - CABLE/OXYGEN

1H 0000-LL-CQA-2492

WT. 6.0 lbs.

VOL. 120.0 in³

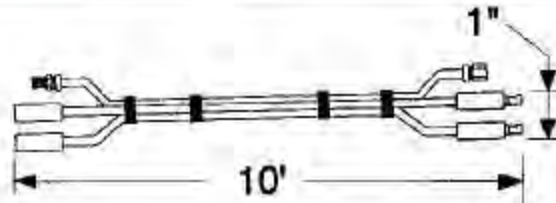

1

Helpful Hints:

Actual Inventory:

PORTABLE EXOTHERMIC CUTTING UNIT (PECU) KIT

Quantity
Required

PECU-CLIP ON WELDER ADAPTER

NSN: 4240-01-250-8263

WT. 0.1 lbs. VOL. 1.1 in³

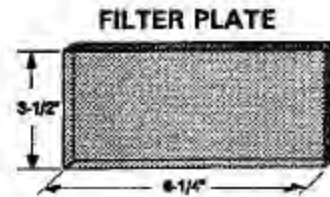

1

Helpful Hints: Fits OBA face piece. Adapter NSN 4240-01-250-8263 used Rayfoe filter plate, shade 6 NSN 4240-01-248-8021 and Lens NSN 4240-00-276-8941.

Actual Inventory:

PECU-MANUAL - OPERATORS

1H 0000-LL-CQA-2500

WT. 1.5 lbs. VOL. 46.8 in³



1

Helpful Hints: Stow with spare parts.

DELETE

Actual Inventory:

PECU-CYLINDER - OXY 48 CUFT

NSN 6830-01-333-3151 (FULL BOTTLE)
NSN 6830-01-333-3152 (REFILL GAS)
NSN 8120-01-326-6750 (EMPTY BOTTLE)

WT. 30.0 lbs. VOL. 538.0 in³



144
CU
ft

Helpful Hints: Three bottles are required in DCRS. (Two spares, one for immediate use.)

Actual Inventory:

PORTABLE EXOTHERMIC CUTTING UNIT (PECU) KIT

Quantity
Required

PECU-PIERCING TORCH ASSEMBLY

- NSN 4240-01-323-1258 HAND SHIELD, WT 0.4 lbs.
- NSN 3433-01-321-3342 3/8" COLLET CHUCK, WT 0.5 lbs.
- NSN 3460-01-321-9161 3/8" NUT ASSEMBLY, WT 0.5 lbs.
- NSN 4933-01-325-6683 PIERCING EXT SHIELD, 0.8 lbs
- NSN 3433-01-321-4195 PIERCING EXT, WT 2.0 lbs.

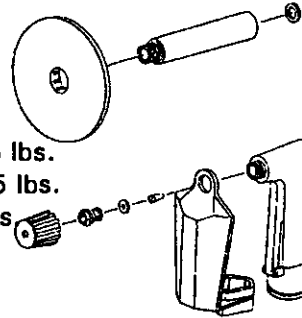

1

WT. 4.2 lbs. VOL. 51.0 in³

Helpful Hints:

Actual Inventory:

PECU-STRIKER-AY - WITH CABLE

1H 0000-LL-CQA-2486

WT. 4.0 lbs. VOL. 27.0 in³

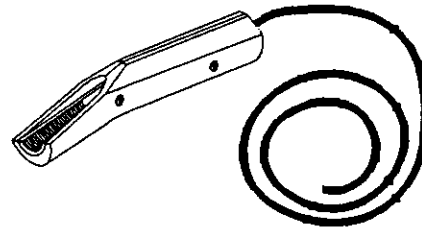

1

Helpful Hints:

Actual Inventory:

PECU-SPARE PARTS PACKAGE

1H 0000-LL-CQA-PECU

WT. 13.0 lbs. VOL. 900.0 in³

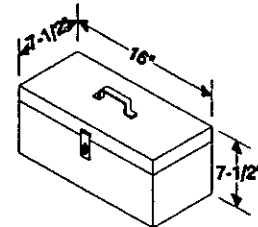

None

Helpful Hints:

Actual Inventory:

PORTABLE ACCESS RESCUE SYSTEM (PARS) KIT

AEL Range: 2-880044276

Shipboard survivability improvement. NDI introduced three manufacturers during Operation Desert Storm. Stowage can be near weather deck access within DCRS area of responsibility, in passageways or in the Crash and Rescue Locker. A laminated inventory list should be provided with this kit.

PORTABLE HYDRAULIC ACCESS / RESCUE SYSTEM (PHARS) KIT

Quantity
Required

1HM 0000-LL-CQA-3817

HOLMATRO TOOLS

1
(See
Hints)

This kit identifies all equipment used for the function of emergency access and personnel rescue during damage control and rescue and assistance operations, when the use of flame/spark producing equipment may not be appropriate. Each ship should have at least one PHARS kit. Items are listed on AEL #2-884444276.

EQUIPMENT DESCRIPTION	DIMENSIONS	LBS	IN ³
1. Cutter	30.75"L x 8.75"W x 5"H	35.0	1345
2. Spreader	35"L x 12"W x 8.5"H	49.0	3570
3. Extension Ram	30.25"L x 4.75"W x 17"H	36.0	2443
4. Engine	21"L x 16"W x 22"H	80.0	7392
5. Box. Tool Kit	36"L x 16"W x 18"H	10.0	1260
6. Hose Reel - 100'	16.5"L x 14"W x 18"H	63.0	4158
7. Extension Hose, 1 x 16'	24"L x 18"W x 3"H	6.0	1296
8. Foot Valve	30"L x 10"W x 5"H	22.0	1500
9. Funnel	8"L x 4"W x 4"H	0.5	128
10. Oil, case - 7 quarts (1 quart illustrated)		13.0	572

- NOTES: 1. Spare hydraulic fluid (7 qts.) stored as designated by DCA.
2. Illustration is for general storage guidance only.

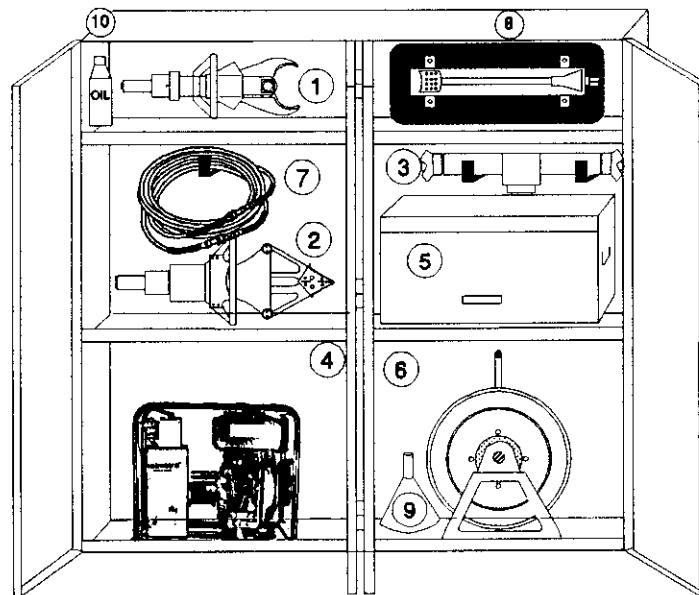

PORTABLE HYDRAULIC ACCESS / RESCUE SYSTEM (PHARS) KIT

Quantity
Required

1HM 0000-LL-CQA-3817

PHOENIX TOOLS

1
(See
Hints)

This kit identifies all equipment used for the function of emergency access and personnel rescue during damage control and shoreside disaster operations, where the use of flame/spark producing equipment may not be appropriate. Each ship should have at least one PHARS kit. Items are listed on AEL #2-884444276.

EQUIPMENT DESCRIPTION		DIMENSIONS	LBS	IN ³
1.	Cutter	21"L x 8"W x 5"H	12.0	840
2.	Spreader	31"L x 13"W x 8"H	48.0	3224
3.	Extension Ram	25"L x 7"W x 3"H	28.0	525
4.	Engine	22"L x 20"W x 20"H	95.0	8800
5.	Hose Reel - see Note 2	21"L x 18"W x 18"H	63.0	6804
6.	Extension Hose, 1 x 15'	24"L x 16"W x 3"H	6.0	1152
7.	Funnel	8"L x 4"W x 4"H	0.5	128
8.	Oil, case - 7 quarts (1 quart illustrated)		13.0	512

- NOTES: 1. Spare hydraulic fluid (7 qts.) stored as designated by DCA.
2. 100' hose with manifold attached to hose (optional).

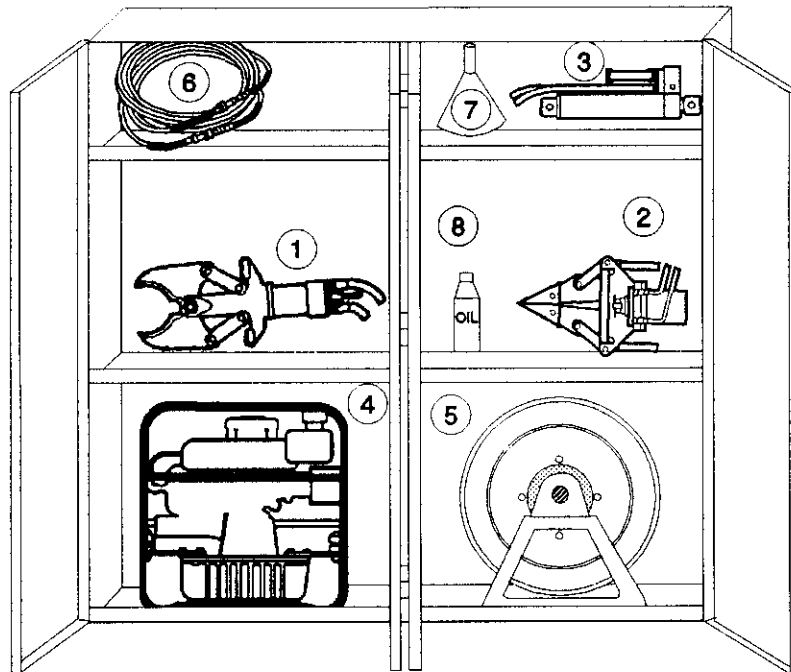

PORTABLE HYDRAULIC ACCESS / RESCUE SYSTEM (PHARS) KIT

Quantity
Required

1HD 0000-LL-CQA-3817

HURST TOOLS

1
(See
Hints)

This kit identifies all equipment used for the function of emergency access and personnel rescue during damage control and shoreside disaster operations, where the use of flame/spark producing equipment may not be appropriate. Each ship should have at least one PHARS kit. Items are listed on AEL #2-884444276.

EQUIPMENT DESCRIPTION		DIMENSIONS	LBS	IN ³
1.	Cutter	31½"H x 11½"W x 7"D	36.0	2536
2.	Spreader	24.3"H x 14"W x 8½"D	48.0	2892
3.	Extension Ram	23"H x 7"W x 3"D	28.0	483
4.	Engine	22"H x 20"W x 20"D	95.0	8800
5.	Attachment Case	11"H x 15¾"W x 3"D	8.0	507
6.	Hose Reel - 100' with Manifold attached to hose	18"H x 16½"W x 16½"D	63.0	4901
7.	Extension Hose, 1 x 16'	24"H x 18"W x 3"D	6.0	1296
8.	Multiple Connection Manifold	15"H x 9½"W x 5"D	10.0	713
9.	Funnel	8"H x 4"W x 4"D	0.5	128
10.	Oil, case - 7 quarts (1 quart illustrated)		13.0	512

NOTES: 1. Spare hydraulic fluid (7 qts.) stored as designated by DCA.

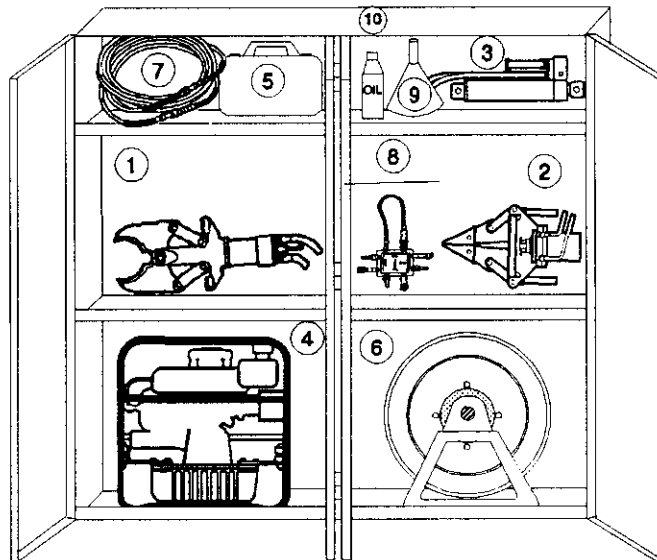

Helpful Hints:

Stowed near weather deck access at the DCRS or within the DCRS zone of responsibility. A laminated kit inventory is to be attached to this kit. Three manufacturers have been listed that provide PHARS to the Fleet. You will only have one.

Actual Inventory:

PORTABLE ELECTRIC ALL PURPOSE RESCUE KIT (PEARS)

Quantity
Required

3HD 4210-01-512-2678

Helpful hints: PEARS is being outfitted on new construction ships and is authorized to replace the PHARS as NAVSEA funds are available.

1
(See
Hints)

Actual Inventory:

REPAIR LOCKER TOOL KIT

AEL Range: 2-880044277 to 4278

A laminated inventory list should be provided with this kit.

REPAIR LOCKER TOOL KIT

Quantity
Required

KIT - REPAIR LOCKER TOOL-DC

1H 0000-LL-CQA-2463

This kit provides additional tools and equipment that are not specifically identified in other kits. Individual items are listed on AEL #2-880044277 and in alphabetical order in this guide.

CHEST TOOL KIT - 23" x 9" x 11"

NSN 5140-00-369-4927

WT. 6.0 lbs.

VOL. 2,277.0 in³

DELETE

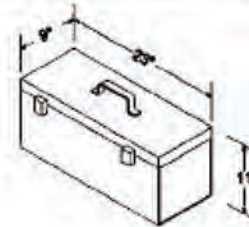

2

Helpful Hints: Utilize box or bag of approximate size as substitute.

Replace with color-coded photo-luminescent marked bag, as NAVSEA funds are available.

Actual Inventory:

CHISEL - BLACKSMITH
FOR CUTTING COLD METALS.
1-1/2" CUTTING EDGE x 6-1/2" LONG
BLADE WITH HANDLE

NSN 5110-00-221-1075

WT. 5.0 lbs.

VOL. 35.4 in³

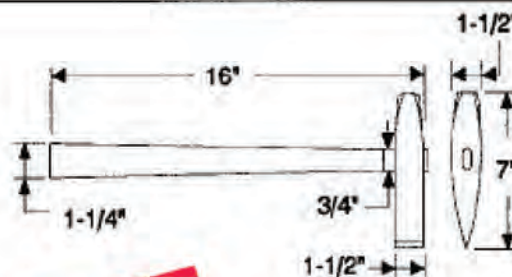

1

Helpful Hints:

DELETE

Actual Inventory:

CHISEL - COLD
HAND HELD, FOR CUTTING BOLTS, RIVET HEADS.
1" CUTTING EDGE/8" LONG

NSN 5110-00-234-1944

WT. 1.5 lbs.

VOL. 6.3 in³

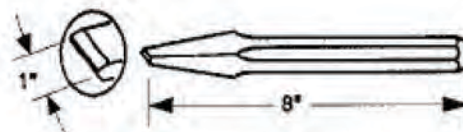

1

Helpful Hints:

DELETE

Actual Inventory:

REPAIR LOCKER TOOL KIT

Quantity
Required

CLAMP "C" -
6" OPENING

NSN 5120-00-203-6431

WT. 6.0 lbs.

VOL. 101.3 in.³

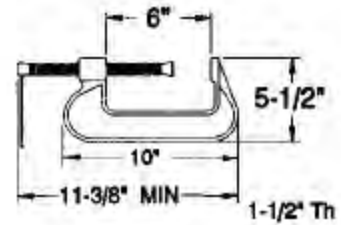

2

Helpful Hints:

Actual Inventory:

CLAMP "C" -
8" OPENING

NSN 5120-00-840-3358

WT. 8.0 lbs

VOL. 175.5 in.³

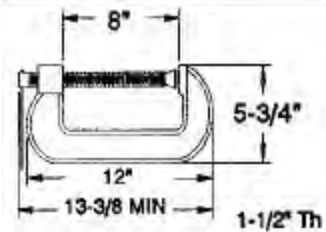

2

Helpful Hints:

Actual Inventory:

CONNECTION - HOSE
DOUBLE MALE 1-1/2"
WITH ROCKER LUGS

NSN 4210-00-277-3374

WT. 0.5 lbs.

VOL. 21.3 in.³



2

Helpful Hints:

DELETE
Move to Adapter Kit

Actual Inventory:

CONNECTION - HOSE
DOUBLE MALE 2-1/2"
WITH ROCKER LUGS

NSN 4210-00-277-3375

WT. 1.0 lbs.

VOL. 53.2 in.³

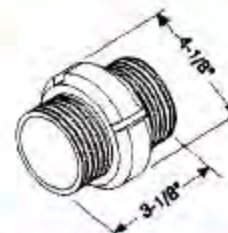

2

Helpful Hints:

DELETE
Move to Adapter Kit

Actual Inventory:

REPAIR LOCKER TOOL KIT

Quantity
Required

CUTTER - CBL HND OPR
TYPE 2

NSN 5110-00-595-8267

WT. 16.0 lbs. VOL. 427.5 in³

DELETE

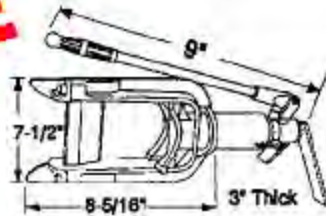

Rep
V
only

Helpful Hints: Requirement for Engineering Repair DCRS only.

Actual Inventory:

CUTTER - PIPE
1/8" TO 2"

NSN 5110-00-293-0460

WT. 12.0 lbs. VOL. 180.0 in³

DELETE

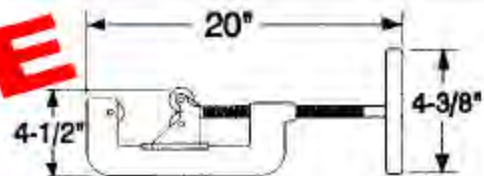

1

Helpful Hints: For small pipes (up to 2"). Protect cutter in stowage. Keep tool lubricated.

Actual Inventory:

CUTTER - PIPE
2-1/2" TO 4"

NSN 5110-00-221-1049

WT. 19.0 lbs. VOL. 443.8 in³

DELETE

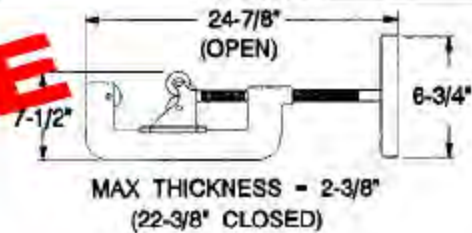

1

Helpful Hints: For pipes up to 4". Protect cutter in stowage. Keep tool lubricated.

Actual Inventory:

REPAIR LOCKER TOOL KIT

Quantity
Required

DRILL TWIST BIT -

NSN 5133-00-227-9650 1/8"
NSN 5133-00-227-9654 3/16"
NSN 5133-00-227-9658 1/4"
NSN 5130-00-277-9666 3/8"
NSN 5133-00-277-9672 1/2"
(1 DOZ EA SIZE PER SET)

WT. 10.0 lbs. VOL. 120.0 in³

DELETE
All But 1/4"



1
doz
each

Helpful Hints: Keep bits lubricated. Stow in protective package.

Actual Inventory:

DRILL - ELECTRIC PORTABLE 1/2"

NSN 5130-00-293-1849

WT. 6.6 lbs VOL. 282.8 in³

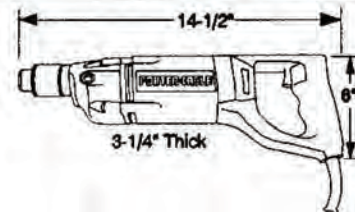

1

Helpful Hints: 1/2" chuck size (maximum drill size 1/2").

Actual Inventory:

GASKET/WASHER - U-SHAPED RUBBER

NSN 4210-00-372-0889

WT. 0.1 lbs VOL. 0.5 in³

DELETE

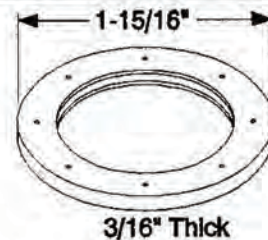

2

Helpful Hints: For All Purpose Nozzle. Install gasket in spud tip insert.

Actual Inventory:

GASKET/WASHER-NON-METALLIC 3"

NSN 5330-00-239-1879

7
each

GASKET/WASHER-4" FLAT

NSN 5310-00-239-1882

10
each

REPAIR LOCKER TOOL KIT

Quantity
Required

GASKET/WASHER - 1-1/2" NON-METALLIC

NSN 5330-00-239-1873

WT. 0.1 lbs VOL. 0.5 in³

Helpful Hints: 1-9/16" inside diameter. Used with 1-1/2" hoses.



10
each

Actual Inventory:

GASKET/WASHER - 1-9/16" FLAT, RUBBER

NSN 5310-00-728-7702

WT. 0.1 lbs VOL. 0.4 in³

Helpful Hints: Used with 1-1/2" hoses.



2
each

Actual Inventory:

GASKET/WASHER - 2-1/2" RUBBER

NSN 5330-00-239-1877

WT. 0.1 lbs VOL. 1.2 in³

Helpful Hints: 2-9/16" inside diameter. Used with 2-1/2" hoses.

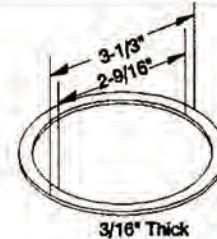

5
each

Actual Inventory:

**HAMMER - BALLPEEN
MACHINIST 2 LB.
16" HANDLE (HICKORY)**

NSN 5120-00-061-8546

WT. 2.5 lbs VOL. 1.0 in³

Helpful Hints:



1

DELETE

Actual Inventory:

REPAIR LOCKER TOOL KIT

Quantity
Required

HOSE - NON-METALLIC
1-1/2" X 15' FIRE HOSE - NO FITTINGS
FOR SAW BLADE PROTECTION

NSN 4720-00-230-6481

WT. 6.3 lbs.

VOL. 133.2 in³

DELETE

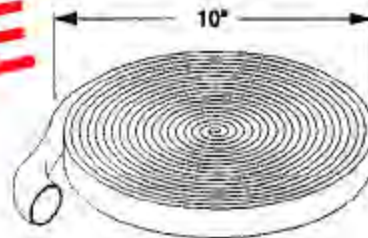

as
needed

Helpful Hints: Recommend utilizing damaged hose for this purpose. For all tools with sharp edges. Used for tool protection and personnel safety.

Actual Inventory:

JACK - HYDRAULIC
10 TON CAPACITY

NSN 5120-00-293-0076

WT. 44.0 lbs

VOL. 861.0 in³

DELETE

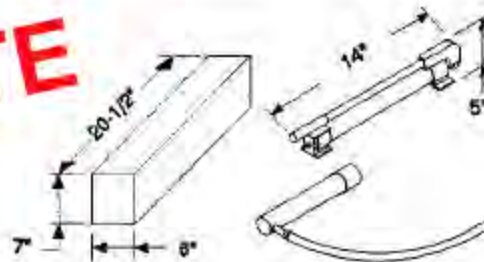

1

Helpful Hints:

Actual Inventory:

MARLINE-TAR - 2 PLY

NSN 4020-00-240-2185

WT. 0.5 lbs.

VOL. 64.0 in³

DELETE



1

Helpful Hints: Comes in box of 20 lbs. or 5 lbs. Cut 131 ft. of marlin from coil or ball. Wrap around wooden dowel (12" broom handle stock). Stow remainder in bag to reduce weight/bulk of kit bag. Start 1-1/2" from end and wrap tight.

Actual Inventory:

REPAIR LOCKER TOOL KIT

Quantity
Required

OAKUM SPUN TAR -

NSN 5330-00-191-5679

WT. 1.0 lbs.

VOL. 448.0 in³



5
lbs.

Helpful Hints: Supply unit of issue is three rolls per box, 50 lbs. or one 5 lb box. Provide 1 lb. in bag. Store in a protective package. Stow the remainder in a box in DCRS to reduce the weight and bulk of the kit bag.

Actual Inventory:

PP - COVER - LENS OBA

NSN 4240-01-052-9901

WT. 0.2 lbs.

VOL. 5.0 in.³

DELETE

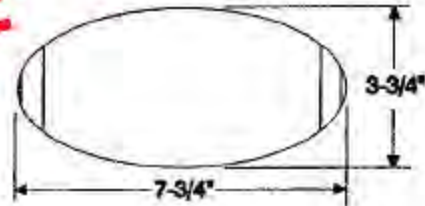

1
each

Helpful Hints: 25 per package.

Actual Inventory:

PP - WRENCH - SPANNER OBA

NSN 5120-01-290-1804

WT. 0.5 lbs.

VOL. 2.0 in.³

DELETE

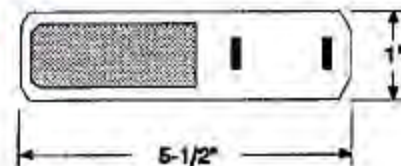

1
each

Helpful Hints:

Actual Inventory:

SAW - 18"
METAL CUTTING EDGE
15 POINTS PER INCH

NSN 5110-00-221-0235

WT. 2.0 lbs.

VOL. 117.0 in.³

DELETE

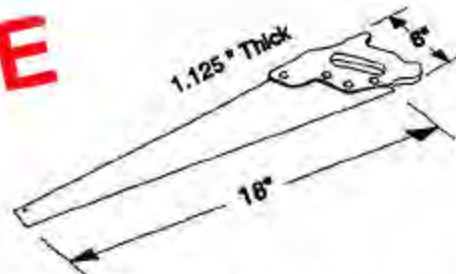

1
each

Helpful Hints:

NOTE: This saw is shaped like a wood saw but has teeth similar to a hacksaw for use in metal cutting. Provide protection for saw teeth (split fire hose).

Actual Inventory:

REPAIR LOCKER TOOL KIT

Quantity
Required

SHEET - SYN RUBBER
1/8" X 36" WIDE ROLL - 10 FT LONG

NSN 5330-00-244-0191

WT. 3.0 lbs

VOL. 576.0 in³

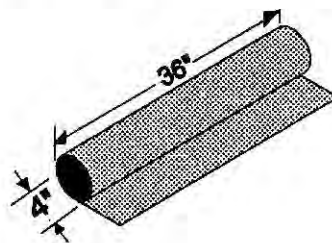

4 ft

Helpful Hints: Used to cut gaskets for backside of strongbacks in banding kit and jubilee patches, box patches and soft patches in the pipe patching kit.

Actual Inventory:

TAPE - ILLUMINESCENT
3" X 50 YD X 6" DIA

NSN 9390-01-078-8660

WT. 2.5 lbs

VOL. 108.0 in³

DELETE



REFLECTIVE TAPE (WHITE)

1
Roll

Helpful Hints: Wrap tape around top 12 inches of hand rail on fireman's ladder to facilitate locating ladder in a smoke filled environment.

Actual Inventory:

WRENCH - MONKEY
(ADJUSTABLE AUTO)
11" LONG, ADJUSTABLE TO 2-3/4"
OPENING
STEEL

NSN 5120-00-473-6476

WT. 2.5 lbs.

VOL. 41.2 in.³

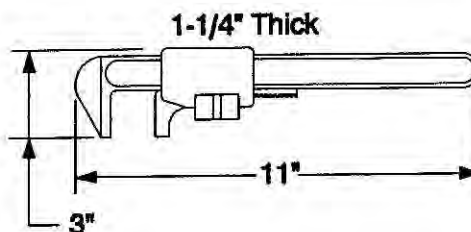

Helpful Hints: Replacement item for 36" Stillson Wrench.

Actual Inventory:

REPAIR LOCKER TOOL KIT

Quantity
Required

**WRENCH PIPE - 14" ADJUSTABLE
STEEL
JAW OPENING 1/2" TO 1-1/2"**

NSN 5120-00-277-1486

WT. 3.2 lbs.

VOL. 45.7 in.³

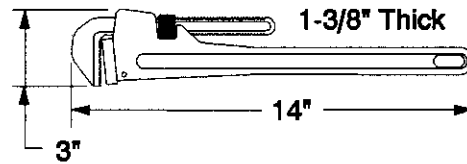

1

Helpful Hints:

Actual Inventory:

**WRENCH PIPE - 18" ADJUSTABLE
STEEL
JAW OPENING 1" TO 1-1/2"**

NSN 5120-00-277-1461

WT. 9.0 lbs

VOL. 108.0 in.³

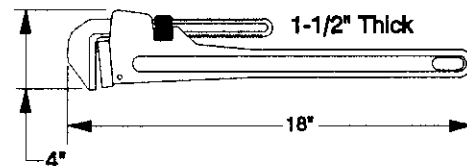

1

Helpful Hints:

Actual Inventory:

**WRENCH SET - SOCKET 1/2" DRIVE
20 PC SET**

NSN 5120-00-081-2307

WT. 20.0 lbs

VOL. 733.0 in.³

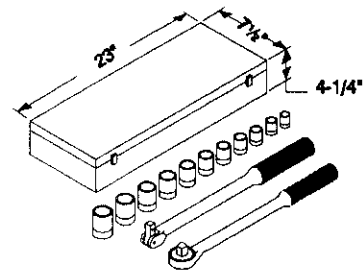

1
set

Helpful Hints:

Actual Inventory:

REPAIR LOCKER TOOL KIT

Quantity
Required

WRENCH - MONKEY
(ADJUSTABLE AUTO)
15" LONG - ADJUSTABLE TO 3-5/8"
OPENING
STEEL

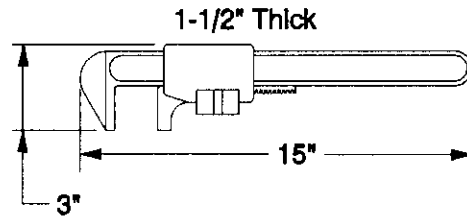

1

NSN 5120-00-264-3793

WT. 3.5 lbs.

VOL. 67.5 in.³

Helpful Hints:

Actual Inventory:

WRENCH - CRESCENT
12" LONG
STEEL

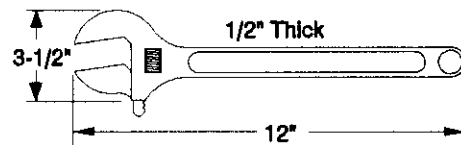

1

NSN 5120-00-264-3796

WT. 2.0 lbs.

VOL. 29.9 in.³

Helpful Hints:

Actual Inventory:

WRENCH - PLIERS 7"
(VICE GRIPS)
1-1/2" JAW OPENING
TWO STRAIGHT JAWS

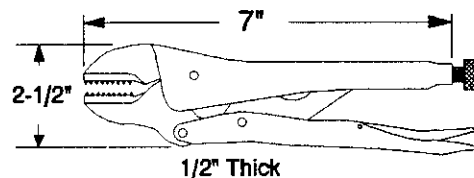

1

NSN 5120-00-277-4243

WT. 0.6 lbs.

VOL. 16.4 in.³

Helpful Hints:

Actual Inventory:

REPAIR LOCKER TOOL KIT

Quantity
Required

WRENCH - PLIERS 8-1/2"
(VICE GRIPS)
1-3/4" JAW OPENING
TWO STRAIGHT JAWS

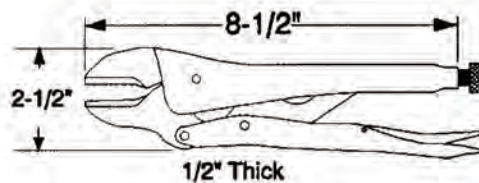

1

NSN 5120-00-277-4244

WT. 1.0 lbs.

VOL. 10.6 in.³

Helpful Hints:

Actual Inventory:

WAND - LGT CHMCL HAN YELLOW
BOX OF 10 WANDS

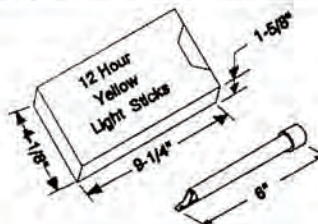

8

NSN 6260-01-074-4230

WT. 11.0 oz

VOL. 62.0 in.³

Helpful Hints: Chem lights should be stowed in bag.

Actual Inventory:

RAKE - OVERHAUL

NSN 4210-00-203-3512

WT. 8.0 lbs.

VOL. 35.0 in.³

Helpful Hints: Replaces overhaul rake
fabricated IAW Dwg No. 804-5959242.
NAVSEA will provide as funds become available.

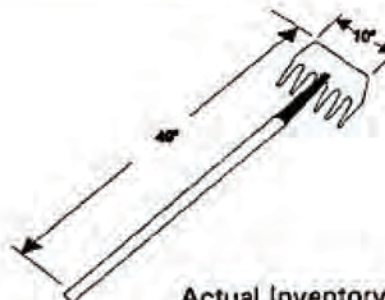

1

Actual Inventory:

SHOVEL - SCOOP

NSN 5120-00-188-8446

WT. 8.5 lbs.

VOL. 1,144 in.³

Helpful Hints: NAVSEA will provide as funds become available.

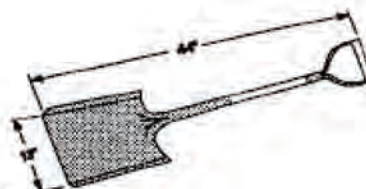

1

Actual Inventory:

RESCUE and ASSISTANCE CHESTS KIT

AEL Range: 2-880044279

Shipboard survivability improvement. This incorporates equipment listed in NWP 62-1C/1D. Not part of DCRS stowage inventory. Should be readily available for rescue and assistance evolutions.

RESCUE AND ASSISTANCE CHESTS KIT

Quantity
Required

KIT - RESCUE AND ASSIST-DC

1H 0000-LL-CQA-2464

This kit identifies all equipment used for the function of providing off ship assistance at sea or in port to conduct fire fighting, dewatering or personnel rescue operations. Individual items are listed on AEL #2-880044279 and in alphabetical order in this guide.

AURAL PROTECTOR, HEADSET -

NSN 4240-00-759-3290

WT. 0.6 lbs VOL. 108.0 in³

Helpful Hints:

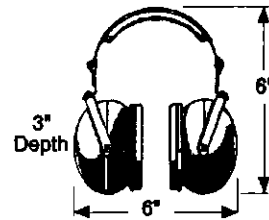

2

Actual Inventory:

CHEST TOOL - 36" x 26" x 20" RESCUE AND ASSISTANCE

1HM0000-LL-CQA-0086

WT. 25.0 lbs. VOL. 18,720.0 in³

Helpful Hints:

Chest shall be painted red and stenciled "Rescue/Assistance" in two inch letters.

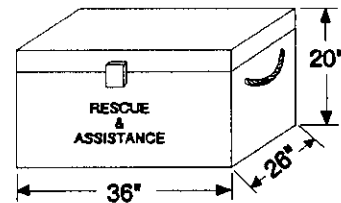

2

Actual Inventory:

CONNECTION - INTERNATIONAL SHIP 2 INTERNATIONAL SHORE CONNECTIONS ARE REQUIRED AS DISCUSSED IN CNSL 3541.1B REPAIR PARTY MANUAL (PAGE 2-52)

NSN 4730-00-932-4753

WT. 9.0 lbs. VOL. 153.1 in³

Helpful Hints:

Bolt slots vice bolt holes, 7 inch OD flange to 2-1/2 inch male hose.

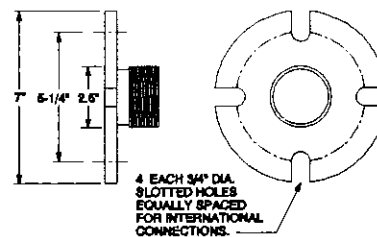

2
each

Actual Inventory:

RESCUE AND ASSISTANCE CHESTS KIT

Quantity
Required

CONNECTION - WYE GATE
2-1/2" INLET x TWO 1-1/2" OUTLETS

NSN 4210-00-255-0234

WT. 11.0 lbs. **VOL.** 185.9 in.³

Helpful Hints:

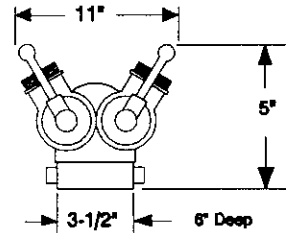

1

Actual Inventory:

GASKET - WASHER, HOSE 2"

1H 0000-LL-CQA-2498

WT. 0.1 lbs **VOL.** 0.5 in.³

Helpful Hints:

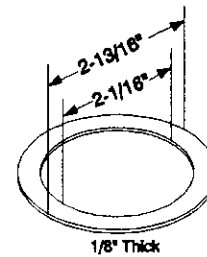

5
each

Actual Inventory:

GASKET/WASHER - 3" RUBBER

NSN 5330-00-239-1879

WT. 0.2 lbs **VOL.** 1.4 in.³

Helpful Hints:

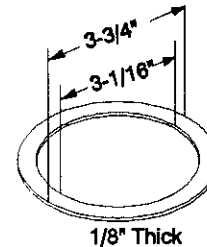

10
each

Actual Inventory:

GASKET/WASHER - 4" RUBBER

NSN 5310-00-239-1882

WT. 0.2 lbs **VOL.** 1.5 in.³

Helpful Hints:

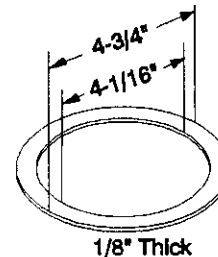

5
each

Actual Inventory:

RESCUE AND ASSISTANCE CHESTS KIT

Quantity
Required

GASKET/WASHER - 1-1/2" NON-METALLIC

NSN 5330-00-239-1873

WT. 0.1 lbs VOL. 0.5 in³

Helpful Hints:

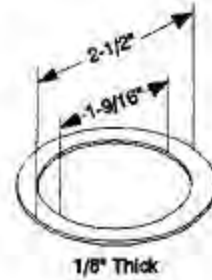

10
each

Actual Inventory:

GASKET/WASHER - 2-1/2" NON-METALLIC

NSN 5330-00-246-2914

WT. 0.1 lbs VOL. 1.9 in³

Helpful Hints:

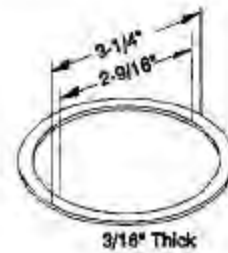

10

Actual Inventory:

INLINE AFFE DUCTOR -

NSN 4210-01-112-3081

WT. 7.0 lbs. VOL. 393.7 in³

Helpful Hints: From NWP 62-1C/1D.

DELETE

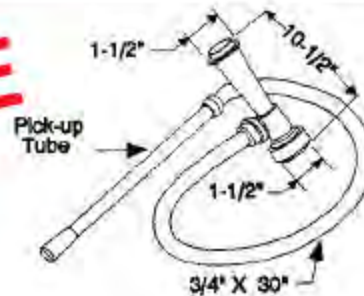

1

Actual Inventory:

NOZZLE - VARIABLE
1-1/2"

NSN 4210-00-465-1906

WT. 9.0 lbs. VOL. 301.8 in³

Helpful Hints: Utilize vari-nozzle onboard. Order as replacement.

DELETE

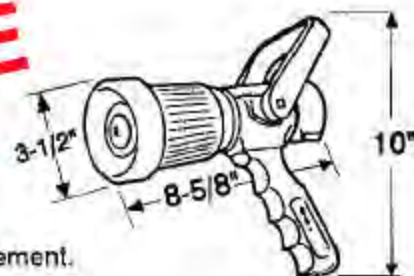

2

Actual Inventory:

RESCUE AND ASSISTANCE CHESTS KIT

Quantity
Required

PP-CANISTER - OXYGEN GEN
(GREEN)

NSN 4240-00-174-1365

(BOX OF 6 CANISTERS)

WT. 4.0 lbs VOL. 178.1 in.³

Helpful Hints:

DELETE

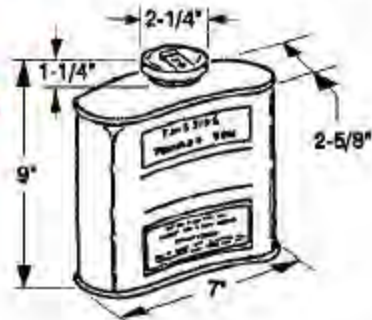

18

Actual Inventory:

REDUCER - HOSE
2-1/2" (F) TO 1-1/2" (M)
WITH ROCKER LUGS

NSN 4210-00-202-7466

WT. 3.0 lbs. VOL. 38.0 in.³

Helpful Hints:

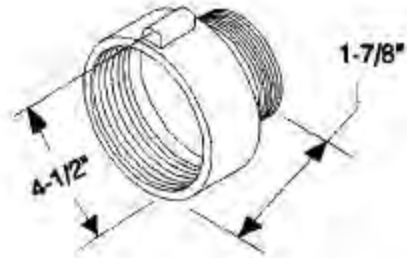

1

Actual Inventory:

REDUCER - HOSE
4" (M) TO 3" (F)
USE WITH P-250/EDUCTOR

NSN 4730-00-618-8593

WT. 11.0 lbs. VOL. 132.1 in.³

Helpful Hints:

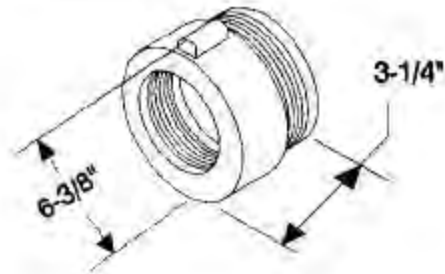

1

Actual Inventory:

RESCUE AND ASSISTANCE CHESTS KIT

Quantity
Required

VALVE - FOOT/STRAINER 3"
FOR P-250 SUCTION HOSE

NSN 4820-00-540-2381

WT. 12.5 lbs VOL. 312.0 in³

DELETE

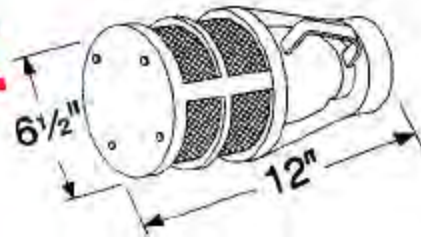

1

Helpful Hints:

Actual Inventory:

WAND - LGT CHMCL HAND YELLOW
BOX OF 10 WANDS

NSN 6260-01-074-4230

WT. 11.0 oz VOL. 62.0 in³

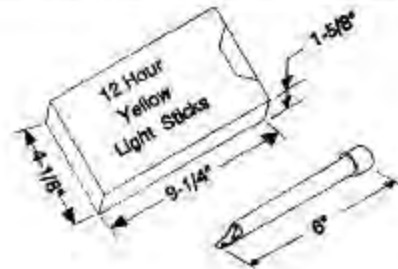

1

Helpful Hints:

Actual Inventory:

WRENCH - SPANNER
ADJUSTABLE HOOK WITH FIXED PIVOT
RANGE FROM 2" TO 4-3/4"

NSN 5120-00-277-9076

WT. 2.0 lbs. VOL. 6.7 in.³



2

Helpful Hints:

Actual Inventory:

WRENCH - SPANNER
3/4" TO 2"

NSN 5120-00-288-8746

WT. 1.3 lbs VOL. 3.0 in³

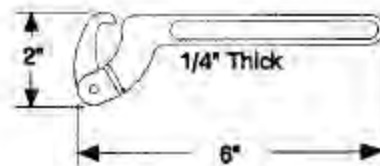

2

Helpful Hints:

Actual Inventory:

SHORING MATERIAL KIT

AEL Range: 2-880044280 to 4281

Large shoring material may be stowed in passageways to provide repair party personnel rapid access. Wooden shoring may be consolidated only as a last resort for stowage. A laminated inventory list should be provided with this kit bag of small items that includes equipment stowage locations.

SHORING MATERIAL KIT

Quantity
Required

KIT - SHORING MATERIAL -DC

1H 0000-LL-CQA-2465

This kit identifies materials used for the function of conducting shoring and plugging operations by using steel and wooden shores. Individual items are listed on AEL #2-880044280 and in alphabetical order in this guide.

BAG-KIT -

NSN 8460-00-606-8366

WT. 2.3 lbs

VOL. 8.45 in³

DELETE

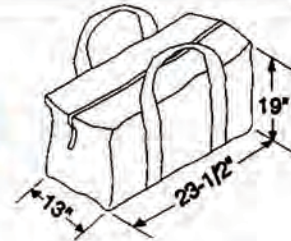

1

Helpful Hints:

Utilize bag of same approximate size as substitute. For stowage of wedges.

Actual Inventory:

SHORING - LUMBER

4" x 4" x 12'

NSN 5510-00-663-4693

WT. 53.2 lbs.

VOL. 192.0 in³

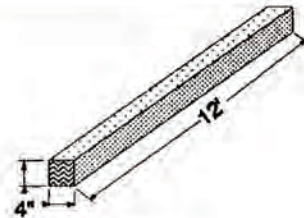

80
B.F.

Helpful Hints: Shoring: Six (6) pieces of 4" x 4" x 12' fire retardant treated lumber.

Actual Inventory:

SHORING STEEL - 6-11 FEET MAX

NSN 2090-00-052-1581

WT. 40.0 lbs.

VOL. 1,152.0 in³

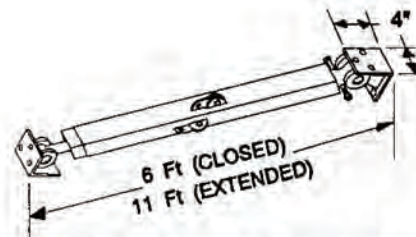

4

Helpful Hints: Adjustable. Stowed in passageway. Lubricate swivel, ball, jack threads and internal rectangular shaft.

Actual Inventory:

SHORING MATERIAL KIT

Quantity
Required

SHORING STEEL - 3-5 FEET MAX

NSN 2090-00-058-3737

WT. 26.0 lbs.

VOL. 576.0 in.³

Helpful Hints: Adjustable. Stored in passageway. Lubricate swivel, ball, jack threads and internal rectangular shaft.

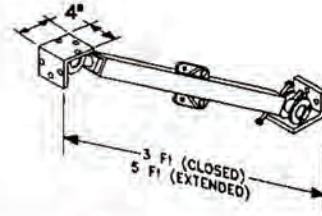

4

Actual Inventory:

WEDGES - WOOD

2" x 4" x 8"

NSN 5510-00-268-3480

WT. 0.7 lbs

VOL. 2.2 in.³

Helpful Hints: Softwood, Douglas Fir. This replaces odd size wedges from kit.

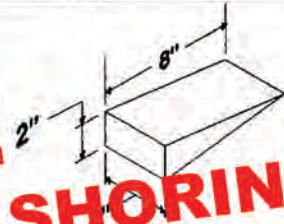

22

Actual Inventory:

WEDGE - WOOD

2-1/4" x 4" x 18"

NSN 5510-00-268-3478

WT. 1.9 lbs

VOL. 1.7 in.³

Helpful Hints: Made of softwood.



8

Actual Inventory:

SHORING TOOL KIT

AEL Range: 2-880044282 to 4283

A laminated inventory list should be provided with this kit.

SHORING TOOL KIT

Quantity
Required

KIT - SHORING TOOL-DC

1HS0000-LL-CJ7-5894

This kit identifies all tools and equipment used for the function of conducting shoring operations by using steel and wooden shores. Individual items are listed on AEL #2-880044282 and in alphabetical order in this guide.

BAG-KIT -

NSN 8460-00-606-8366

WT. 2.3 lbs

VOL. 5,804.5 in³

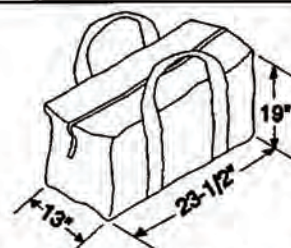

1

Helpful Hints: Utilize bag of same approximate size as substitute. Do not overpack bag. Delete the word "PLUGGING" on existing tool kit bag. Stencil all new kit bags "SHORING TOOL KIT" in 2" black letter. Replace with color-coded photo-luminescent marked bag, MIL-K-48135 as NAVSEA funds are available.

Actual Inventory:

BATTEN-SHORING - 2" X 2" X 4'6" to 7'

5210-01-418-4746

WT. 2.0 lbs

VOL. 864.0 in³
270.0 in³ (old)

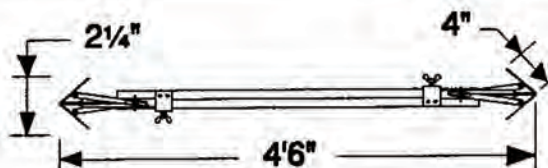

1

Helpful Hints: May be stowed within the DCRS locker or in the vicinity of wooden shoring rack.

Actual Inventory:

BATTEN-SHORING - 2" X 2" X 7' TO 12'

5210-01-418-4748

WT. 3.0 lbs

VOL. 1,316.0 in³
390 in³ (old)

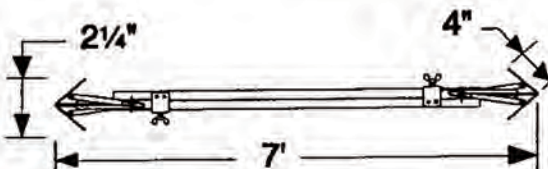

1

Helpful Hints: May be stowed within the DCRS locker or in the vicinity of wooden shoring rack.

Actual Inventory:

SHORING TOOL KIT

Quantity
Required

CHISEL - COLD HAND

NSN 5110-00-221-8132

WT. 1.3 lbs.

VOL. 2.3 in³

DELETE

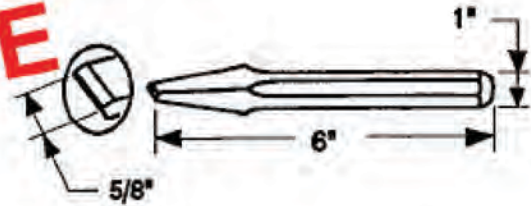

1

Helpful Hints: Recommend providing protective cover for tip. Provide a light coat of lubrication to prevent rust.

Actual Inventory:

CHISEL - FIRMER 1-1/2" X 6-1/4" BLADE

NSN 5110-00-640-5423

WT. 4.0 oz

VOL. 8.2 in³

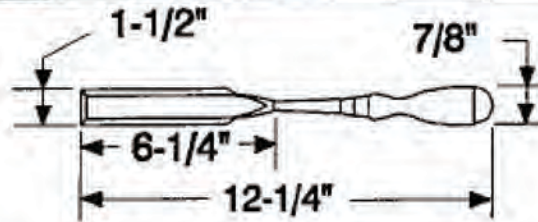

2

Helpful Hints: Recommend providing protective cover for tip. Provide a light coat of lubrication to prevent rust.

Actual Inventory:

DELETE

WEDGES - WOOD
2" x 4" x 8"

NSN 5510-00-268-3480

WT. 0.7 lbs

VOL. 32.0 in³

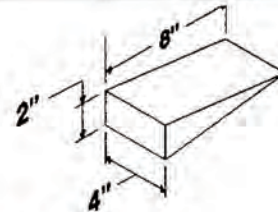

22

Helpful Hints: Softwood, Douglas Fir. This replaces odd size wedges from kit.

Actual Inventory:

WEDGE - WOOD
2-1/4" x 4" x 18"

NSN 5510-00-268-3478

WT. 1.9 lbs

VOL. 81.0 in³

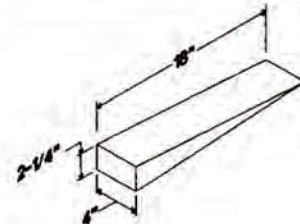

8

Helpful Hints: Made of softwood.

Actual Inventory:

SHORING TOOL KIT

Quantity
Required

**CLAMP "C" -
6" OPENING**

NSN 5120-00-203-6431

WT. 6.0 lbs.

VOL. 101.3 in.³

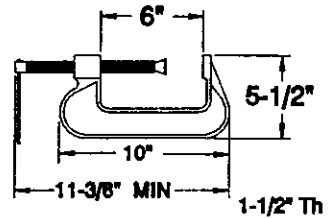

4

Helpful Hints: Lubricate threads.

Actual Inventory:

**CLAMP "C" -
8" OPENING**

NSN 5120-00-840-3358

WT. 8.0 lbs

VOL. 175.5 in.³

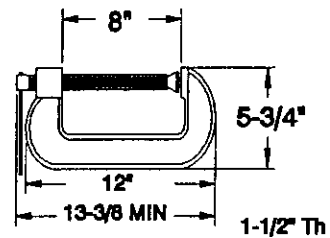

4

Helpful Hints:

Actual Inventory:

**HAMMER - RIPPING
CARPENTER'S STRAIGHT CLAW
13" TO 14" HANDLE-FIBERGLASS
1-1/4" LB. HEAD**

NSN 5120-00-892-5744

WT. 1.8 lbs.

VOL. 105.9 in.³

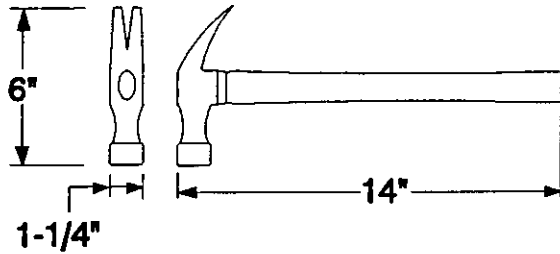

1

Helpful Hints:

Actual Inventory:

SHORING TOOL KIT

Quantity
Required

HATCHET - HALF TYPE "C"

NSN 5110-00-228-3161

WT. 2.1-2.6 lbs

VOL. 112.5 in³

Helpful Hints:

Recommend providing protective cover for blade.



1

DELETE

Actual Inventory:

MAUL - SHIP

5 LB., 32" HANDLE

NSN 5120-00-255-1476

WT. 6.7 lbs.

VOL. 542.5 in.³

Helpful Hints:

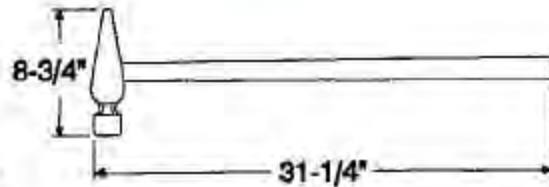

2

Actual Inventory:

**NAIL COM 16D - 4" LENGTH
FOR SHORING KIT**

**NSN 5315-00-753-3885
(BOX)**

WT. 1.0 lb

VOL. 40.5 in³

Helpful Hints:



Actual Inventory:

SHORING TOOL KIT

Quantity
Required

**NAIL COM 20D - 4-1/2" LENGTH
FOR SHORING KIT**

DELETE



1 lb

**NSN 5315-00-010-4665
(BOX)**

WT. 1.0 lb

VOL. 40.5 in³

Helpful Hints:

Actual Inventory:

PAIL - 3 GALLON

DELETE

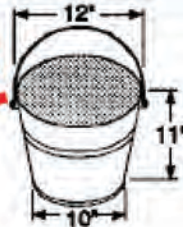

1

NSN 7240-00-274-3875

WT. 2.0 lbs.

VOL. 1,320.0 in³

Helpful Hints:

Actual Inventory:

PENCIL - CARPENTERS

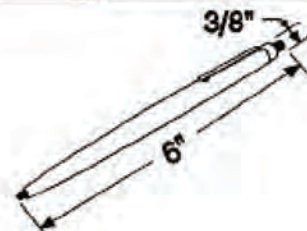

1 dz

NSN 7510-00-275-7213

WT. 0.5 oz

VOL. 0.6 in³

Helpful Hints:

Actual Inventory:

RULE - MULTIPLE FOLDING

DELETE



1

NSN 5210-00-293-3393

WT. 1.2 lbs.

VOL. 1.8 in³

Helpful Hints:

Actual Inventory:

SHORING TOOL KIT

Quantity
Required

SAND - BUCKET (3 GAL.)
SHIP'S FORCE PROVIDE

1HA0000-LL-CJ6-8812

WT. 41.3 lbs.

VOL. 1320.0 in.³



1 lb

Helpful Hints: Sand: 3 gal = 693 in³ & 39.3 lbs (full)
Bucket WT = 2.0 lbs

Actual Inventory:

SAW - CIRCULAR
ELECTRIC, PORTABLE
10" BLADE

NSN 5130-00-889-8991

WT. 35.0 lbs.

VOL. 2200.8 in.³

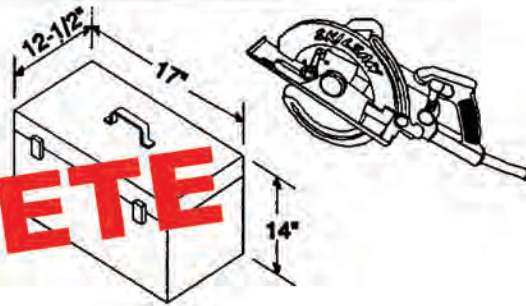

1

Helpful Hints: Electrical safety check item.

Actual Inventory:

SAW - HAND 26"
CROSS CUT - BEVEL FILED TEETH
SPRING SET

NSN 5110-00-596-0921

WT. 2.6 lbs.

VOL. 69.0 in.³

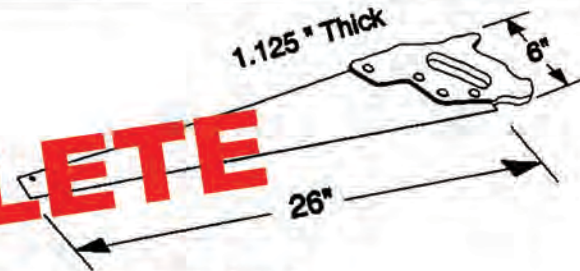

Helpful Hints: Recommend providing protective cover (split fire hose).

Actual Inventory:

SHORING TOOL KIT

Quantity
Required

SAW - SHORT CUT - HAND, 15"
TOOL BOX 9 PT AGGRESSIVE CUT

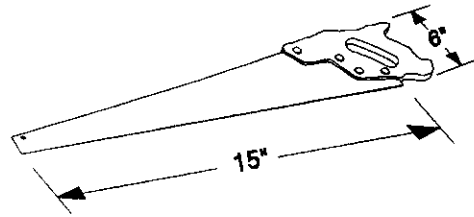

1

NSN

WT. 2.0 lbs.

VOL. 108.0 in.³

Helpful Hints: This saw cuts 50% faster than conventional saws and will cut damp or wet wood. Recommend providing protective cover (split fire hose). The manufacturer is Stanley. NAVSEA will provide as funds are available to replace hand saw 26" NSN 5110-00-596-0921.

Actual Inventory:

SQUARE - CARPENTER
24" LONG
STEEL

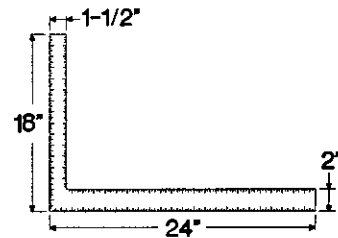

1

NSN 5210-00-810-3490

WT. 2.7 lbs.

VOL. 48.0 in.³

Helpful Hints: Recommend keeping a light coat of oil on square to prevent rust.

Actual Inventory:

TAPE MEASURE - STEEL
1" X 25 FT

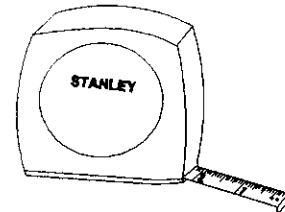

1

NSN 5210-01-335-1614

WT. 0.5 lbs.

VOL. 2.8 in.³

Helpful Hints: NAVSEA will provide as funds are available.

Actual Inventory:

**KIT COMBINED
WITH INVESTIGATOR'S KIT**

SOUNDING KIT

AEL Range: 2-880044283 to 4284

A laminated inventory list should be provided with this kit.

SOUNDING KIT

Quantity
Required

KIT - SOUNDING-DC

1HM0000-LL-CQA-0096

This kit identifies all equipment used for the function of conducting soundings of tanks, voids and other compartments suspected of flooding. Individual items are listed on AEL #2-880044284 and in alphabetical order in this guide.

BAG, LINEMAN TOOL -

NSN 5140-00-288-7763

WT. 3.1 lbs

VOL. 594.0 in³

DELETE

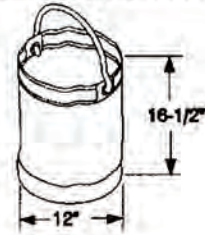

1

Helpful Hints: Utilize bag of approximate size as substitute.

Actual Inventory:

CHALK - CARPENTER'S WHITE

NSN 7510-00-272-9256

(BOX)

WT. 10.0 oz

VOL. 105.0 in³

**MOVE TO
INVESTIGATOR'S KIT**

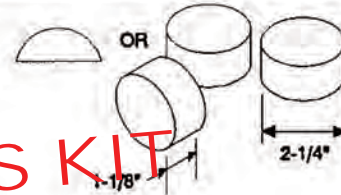

3
pieces

Helpful Hints: Provide 3 pieces of chalk from box to make up kit.

Actual Inventory:

MESSAGE BLANKS -

1HS0000-LL-CJA-1884

(PAD OF 100)

WT. 0.5 lbs

VOL. 1.0 in³

DELETE

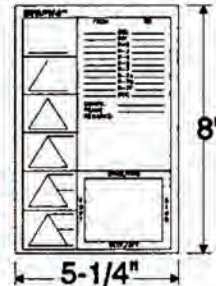

1

Helpful Hints: Prepare locally IAW NWP 62-1C/1D.

Actual Inventory:

SOUNDING KIT

Quantity
Required

PASTE - WATER IND

NSN 6850-00-001-4194

WT. 1.0 oz

Helpful Hints: Shelf life item.



1
oz.
tube

Actual Inventory:

PEN - BALL POINT BLACK

NSN 7520-00-935-7136

WT. 0.5 oz

Helpful Hints:

VOL. 0.3 in³

DELETE



1 dz

Actual Inventory:

PENCIL - CHINA MARKER BLACK

NSN 7510-00-240-1526

WT. 0.5 oz

Helpful Hints:

VOL. 0.6 in³

MOVE TO INVESTIGATOR'S KIT

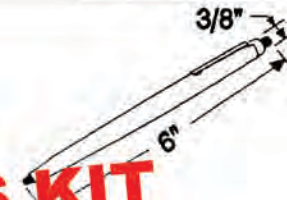

1 dz

Actual Inventory:

RAGS - COTTON

NSN 7920-00-205-1711

(BALE)

WT. 50.0 lbs.

Helpful Hints: Provide 3 rags from the bale to make up kit. Stow bale in DCRS or work center storeroom.

MOVE TO INVESTIGATOR'S KIT



3
rags

Actual Inventory:

SOUNDING KIT

Quantity
Required

SOUNDING LIST -
LOCALLY PREPARED

1HM0000-LL-CQA-0098

WT. 0.2 lbs.

VOL. 2.31



1

MOVE TO INVESTIGATOR'S KIT

Helpful Hints: Sounding list should not be confused with the daily liquid load list. Sounding list will give depths and the amount of liquid held in tanks and voids when flooded/filled.

Actual Inventory:

TAPE - MEAS SOUNDING
50 FT

NSN 5120-00-221-1886

WT. 2.0 lbs.

VOL. 9.1

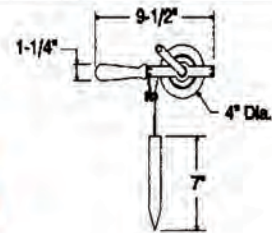

2

DELETE

Helpful Hints:

Actual Inventory:

THIEF SAMPLER - (BOTTOM)

1HS0000-LL-CJ7-5896

WT. 3.0 lbs

VOL. 8.2



1

MOVE TO INVESTIGATOR'S KIT

Helpful Hints:

Actual Inventory:

SOUNDING KIT

Quantity
Required

WRENCH - CRESCENT
15" LONG - ADJUSTABLE TO 1.698 IN.
STEEL

NSN 5120-00-423-6728

WT. 4.0 lbs.

VOL. 22.9 in.

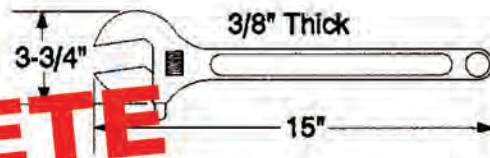

1

DELETE

Helpful Hints:

Actual Inventory:

WRENCH SOUNDING CAP -
(SIZE AS REQUIRED)

1HM0000-LL-CQA-0099

WT. 1.5 lbs

VOL. 48.0 in.



1

**MOVE TO
INVESTIGATOR'S KIT**

Helpful Hints:

Fabricate locally. Sounding tube wrench will be sized according to the specific ship. If more than one size is required, all sizes will be provided in the kit.

Actual Inventory:

TRAINING KIT

AEL Range: 2-880044286

This kit can be stowed in ships designated training areas (crew's mess, DCPO workshop or DCA designated area)

TRAINING KIT

Quantity
Required

KIT - TRAINING-DC

1H 0000-LL-CQA-2466

This kit identifies all equipment used for the function of fire fighting and emergency egress training in a smoke filled environment. Individual items are listed on AEL #2-880044286 and in alphabetical order in this guide.

FLUID - SMOKE GENERATOR -

NSN 1365-01-367-5695

1
ea

WT. 20.0 lbs.

VOL. 1,792.0 in³

Helpful Hints: Unit of issue is 1 case consisting of six (6) 1/2 gallon containers. Each 1/2 gallon will last for 40 minutes of operation. For Symtron system smoke generator listed below.

Actual Inventory:

SMOKE GENERATOR -

NSN 1040-01-302-0470

WT. 20.0 lbs (empty) VOL. 1,640.6 in³
24.0 lbs (full)

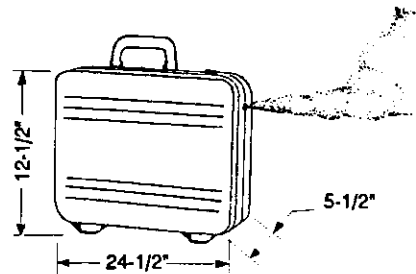

1

Helpful Hints: Fluid for the smoke generator comes in a case of 6 bottles.

WELDING EQUIPMENT KIT

AEL Range: 2-880044287 to 4288

Utilize onboard material to build this kit. A laminated inventory list should be provided with this kit.

WELDING EQUIPMENT KIT

Quantity
Required

KIT - WELDING EQUIPMENT-DC

1H 0000-LL-CQA-2439

This kit identifies all equipment used for the function of performing emergency welding operations, such as reinforcing or repairing hull, deck, bulkhead or piping systems. Individual items are listed on AEL #2-880044287 and in alphabetical order in this guide.

Helpful Hints: Only welding machine to be programmed for NAVSEA funding.

**APRON-WELDERS - BIB-SPLIT LEG TYPE, 0.025" THICK
CATTLE WIDE LEATHER**

NSN 8415-00-250-2531

WT. 2.0 lbs

VOL. 68.2 in³

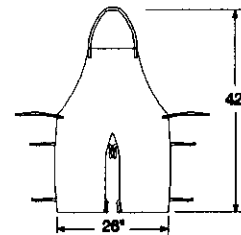

1

Helpful Hints: Replacement item.

Actual Inventory:

BAG-KIT -

NSN 8460-00-606-8366

WT. 2.3 lbs

VOL. 5,804.5 in³

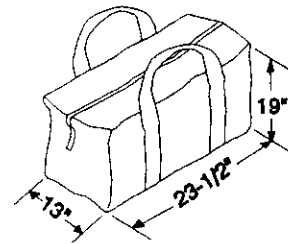

1

Helpful Hints:

Actual Inventory:

BRUSH - WIRE

NSN 7920-00-291-5815

WT. 1.0 lbs

VOL. 26.0 in³

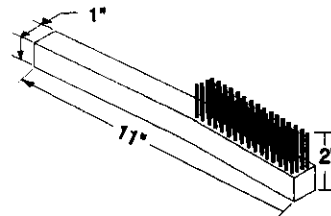

1

Helpful Hints:

Actual Inventory:

WELDING EQUIPMENT KIT

Quantity
Required

CABLE - ASSEMBLY - WELD
LEAD 50 FT
WELDING KIT
NSN 6145-00-914-9010

WT. 16.0 lbs. VOL. 378.0 in³

Helpful Hints: TRXF 84 sz 1 electrical cable.

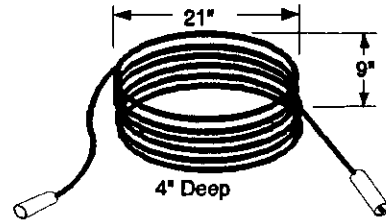

Actual Inventory:

CABLE - ASSEMBLY - GROUND
LEAD 25 FT
WELDING KIT

NSN 6145-00-914-9010

WT. 16.0 lbs. VOL. 378 in³

Helpful Hints: TRXF 84 sz 1, electrical cable.

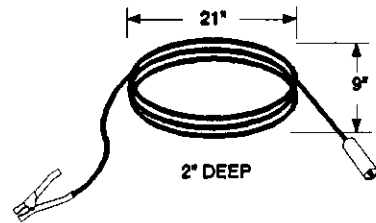

Actual Inventory:

CABLE - CONNECTOR M/F

NSN 4935-01-246-7626

WT. lbs. VOL. in³

Helpful Hints: TRXF 84 sz 1, electrical cable.

4
ea

Actual Inventory:

CLAMP - WELDING - GROUNDING

NSN 5940-00-156-3322

WT. lbs. VOL. in³

Helpful Hints: Attach to ground cable lead.

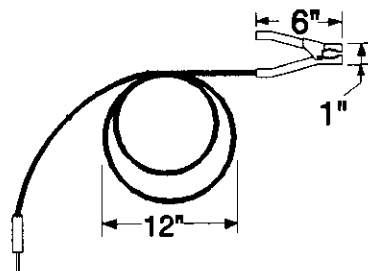

1
ea

Actual Inventory:

WELDING EQUIPMENT KIT

Quantity
Required

CLOTH - SILICA WELDER'S - 1/8" THICK

NSN 8305-01-035-1058

WT. 6.0 lbs

VOL. 1,640.0 in³

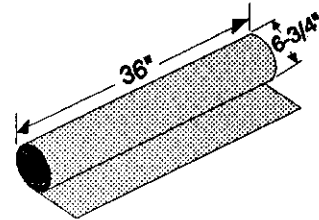

3
Yards

Helpful Hints: Replacement item.

Actual Inventory:

PECU-GLOVES - WELDERS

1H 000-LL-CQA-2493 (SELECT SIZE)

NSN 8415-00-268-7860 SIZE MED

NSN 8415-00-268-7859 SIZE LRG

WT. 1.5 lbs

VOL. 74.2 in³

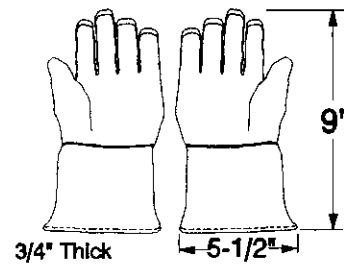

1

Helpful Hints: Replaces welder's mittens.

Actual Inventory:

HELMET - WELDER CL 2

NSN 4240-00-540-0623

WT. 1.8 lbs.

VOL. 828.7 in³

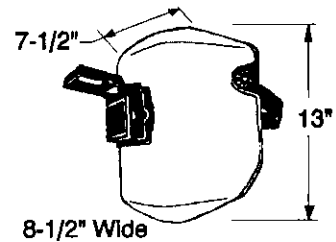

1

Helpful Hints:

Actual Inventory:

WELDING EQUIPMENT KIT

Quantity
Required

HOLDER - ELECTRODE WELD

NSN 3439-00-238-1638

WT. 1.1 lbs

VOL. 34.0 in³

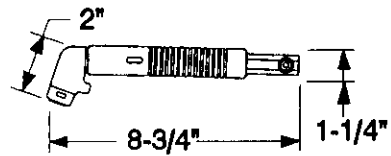

1

Helpful Hints:

Actual Inventory:

JACKET - WELDERS

1H 0000-LL-CQA-2505 (SELECT SIZE)

NSN 8415-00-268-8262 SIZE 34

NSN 8415-00-268-8263 SIZE 38

NSN 8415-00-268-8264 SIZE 42

NSN 8415-00-268-8265 SIZE 46

NSN 8415-00-268-8266 SIZE 50

WT. 5.0 lbs.

VOL. 1,296.0 in³

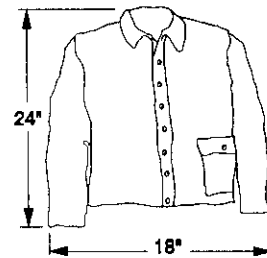

Helpful Hints:

Actual Inventory:

LENS - HLMT WLDR CLEAR

NSN 4240-00-203-7764

WT. 0.1 lbs.

VOL. 1.1 in³

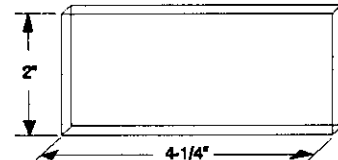

2 ea

Helpful Hints: Not NAVSEA funded.

Actual Inventory:

WELDING EQUIPMENT KIT

Quantity
Required

**LENS - HLMT WLDR SHADE 12
FOR TIG WELDING**

NSN 4240-00-276-8941

WT. 0.1 lbs.

VOL. 1.1 in³

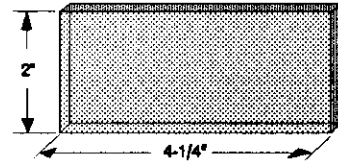

2 ea

Helpful Hints:

Actual Inventory:

SHIELD - WELDER HAND HELD

NSN 4240-00-270-4415

WT. 1.5 lbs

VOL. 2,304.0 in³

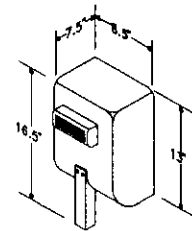

1

Helpful Hints: Not NAVSEA funded.

Actual Inventory:

TERMINAL - QDSCNT

NSN 5940-00-197-4963 (F-SPARE)

NSN 5940-00-196-2289 (M-SPARE)

WT. 0.2 oz

VOL. 1.6 in³

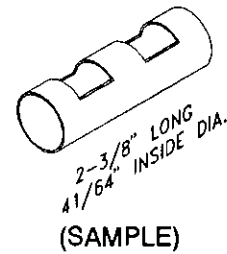

1

Helpful Hints: Not NAVSEA funded.

Actual Inventory:

WELDING EQUIPMENT KIT

Quantity
Required

WELDING MACHINE - 300 AMP
SEE APL 823770002

NSN 3431-01-206-1080

WT. 70.0 lbs. **VOL.** 3,230.0 in³

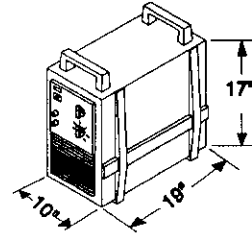

1

Helpful Hints: NAVSEA outfitting to Fleet is programmed for FY 95/96. Utilize current shipboard DCRS and repair shop welders to count for DCRS inventory. Use existing material to make welder's kit.

Actual Inventory:

DAMAGE CONTROL UNIT LOCKER (DCUL)

AEL Range: 2-880044212 to 4215

Utilize onboard material to build this kit. A laminated inventory list should be provided with this kit.

DCUL

Quantity
Required

AX - PICK HEAD - CARBON STEEL
TYPE II 5" CUTTING EDGE

NSN 4210-00-142-4949

WT. 8.4 lbs. VOL. 545.5 in.³

Helpful Hints:

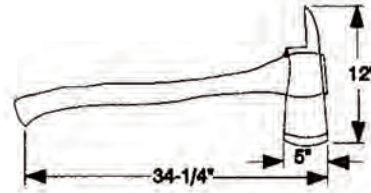

1
each

Actual Inventory:

BATTERY D CELL 1.5 VOLT

NSN: 6135-00-835-7210

WT. 0.5 lbs VOL. 3.5 in.³

Helpful Hints:

DELETE

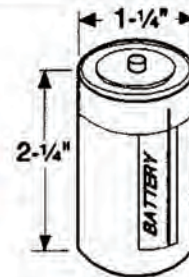

1
pkg

Actual Inventory:

CLIPBOARD - 9" x 17"

NSN 7520-00-240-5503

WT. 0.2 lbs VOL. 19.1 in.³

Helpful Hints:

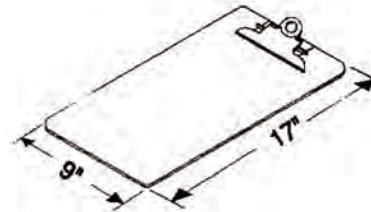

2
ea

Actual Inventory:

FLASHLIGHT - INVESTIGATOR

NSN 6230-01-281-3775

WT. 1.5 lbs VOL. 62.5 in.³

Helpful Hints: Two per DCRS. Stow with Investigator's Kit.



4

Actual Inventory:

DCUL

Quantity
Required

CROWBAR -
TYPE 2 SIZE 4
62" STRAIGHT STOCK, PINCH POINT

NSN 5120-00-224-1390

WT. 18.0 lbs. **VOL.** 96.9 in.³

DELETE

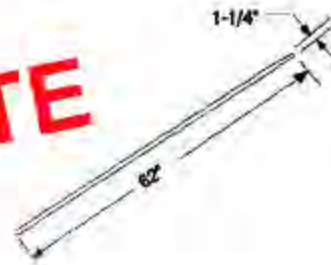

1
ea

Helpful Hints:

Actual Inventory:

CUTTER BOLT - BOLT
24" LONG 3/8" CAPACITY
CUT WROUGHT IRON, ANNEALED
SOFT STEEL BOLTS, RIVETS,
AND COLD DRAWN SCREW STOCK.

NSN 5110-00-596-9156

WT. 7.0 lbs. **VOL.** 171.9 in.³

MAX. THICKNESS = 1-3/4"

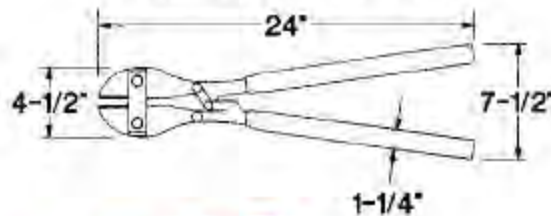

1
ea

DELETE

Helpful Hints:

Actual Inventory:

DECON KIT - M291
SKIN DECON

NSN 4230-01-276-1905

WT. 3.2 oz **VOL.** 19.2 in.³

DELETE



AR

Helpful Hints:

Stored with MCU-2/P mask. Stowed in DCRS, CBR locker or CBR storeroom.
Allowance is 138% SMD or 1 box of 20 kits per 14%. Includes 33% SMD or 1 skin decon kit per
3 personnel for annual training.- M291

Actual Inventory:

DCUL

Quantity
Required

**FLASHLIGHT - WATERPROOF
WITHOUT "D" CELL BATTERIES
WITH 2 LAMPS, 1 SPOT AND 1 DIFFUSING.
2 FILTERS, 1 BLACKOUT AND 1 RED LENS.**

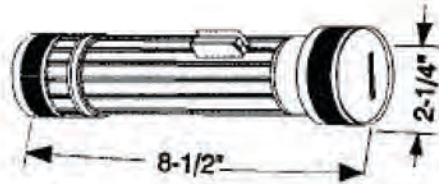

4

NSN 6230-00-270-5418

WT. 3.0 oz

VOL. 43.1 in³

Helpful Hints:

DELETE

Actual Inventory:

**HAMMER - BALLPEEN
MACHINIST 2 LB.
16" HANDLE (HICKORY)**

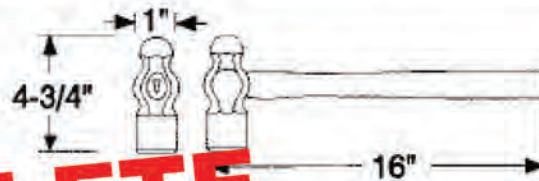

1

NSN 5120-00-061-8546

WT. 2.5 lbs

VOL. 7.0 in³

Helpful Hints:

DELETE

Actual Inventory:

**HOSE - 1-1/2" x 50 FT.
NON-METALLIC**

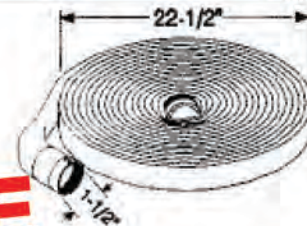

2

NSN 4210-01-131-0249

WT. 25.0 lbs.

VOL. 1,772.0 in³

Helpful Hints:

DELETE

Actual Inventory:

KIT - ELECTRICAL REPAIR-DC

1H 0000-LL-CQA-2449

1

Used in damage control repair stations by qualified repair party electricians, this kit identifies all equipment used for the function of providing repairs to electrical panels, lighting, wireways and portable electrical equipment.

DCUL

Quantity
Required

KIT - EMERGENCY COMM-DC

1H 0000-LL-CQA-2451

1

This kit identifies all equipment used for the function of providing emergency communications at battle stations or other general shipboard casualties.

KIT - INVESTIGATOR - DC

1H 0000-LL-CQA-2457

2

This kit identifies all equipment used for the function of performing the preliminary survey of a known or suspected damage/fire/flooding area. Individual items are listed on AEL #2-880044262 and in alphabetical order in this guide.

**MESSAGE BLANKS -
LOCALLY PREPARED
REFER TO CNSL INT 3541.1B PG 4-5**

1HS0000-LL-CJA-1884

(PAD OF 100)
WT. 0.5 lbs

VOL. 21.0 in³

DELETE

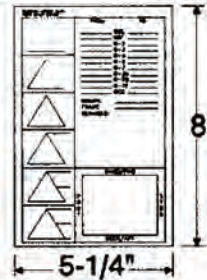

1
pad

Helpful Hints:

Actual Inventory:

DCUL

Quantity
Required

PP-BOOTS - FIREMAN

1H 0000-LL-CJ6-8462 SELECT SIZE
NSN 8430-00-753-5935 SIZE 05
NSN 8430-00-753-5936 SIZE 06
NSN 8430-00-753-5937 SIZE 07
NSN 8430-00-753-5938 SIZE 08
NSN 8430-00-753-5939 SIZE 09
NSN 8430-00-753-5940 SIZE 10
NSN 8430-00-753-5941 SIZE 11
NSN 8430-00-753-5942 SIZE 12
NSN 8430-00-753-5943 SIZE 13
NSN 8430-00-753-5944 SIZE 14
NSN 8430-00-753-5945 SIZE 15

(PAIR)

WT. 6.7 lbs

VOL. 3,935.2 in³

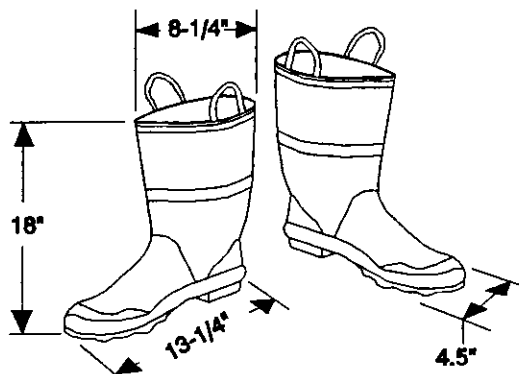

4

Helpful Hints: Each OBA should have boots available. Can be stowed with OBAs or in DCRS. Fireman boots are authorized for use by Repair Party Electricians (Nov 86 NAVSHIPS Safety Bulletin).

Actual Inventory:

PP-GLOVES - FIREMAN

1HM0000-LL-CQA-2201 SELECT SIZE
NSN 8415-01-421-1368 SIZE SML
NSN 8415-01-421-1371 SIZE MED
NSN 8415-01-421-1373 SIZE LRG
NSN 8415-01-421-1375 SIZE X-LRG
NSN 8415-01-421-1376 SIZE XX-LRG

(PAIR)

WT. 2.0 lbs.

VOL. 108.0 in³

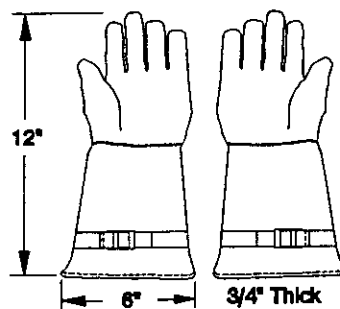

4
pair

Helpful Hints: Used for each OBA. Replace stock when worn with new firefighter's glove which has an aluminized back & knit wristlet. NSN: 8415-01-335-7901 (XS) thru 8415-01-335-7905 (XL).

Actual Inventory:

DCUL

Quantity
Required

PP-GLOVES - ANTIFLASH

NSN 8415-01-267-9661
(PAIR)

WT. 1.0 oz

VOL. 11.3 in³

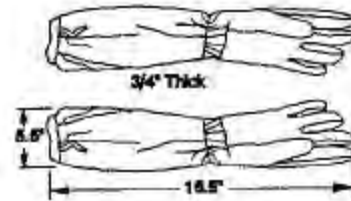

AR

Helpful Hints:

Stored with life preserver.

Actual Inventory:

PP-HELMET - BATTLE

1HS0000-LL-CJ7-5888

WT. 3.0 lbs

VOL. 1,025.4 in³

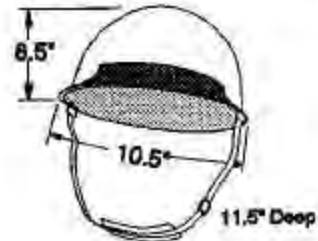

AR

Helpful Hints:

DELETE

Actual Inventory:

PP-HELMET - FIREMAN

NSN 8415-01-271-8069

WT. 2.9 lbs

VOL. 1,320.0 in³



4

Helpful Hints: Stored in helmet rack in passageway, on hook, butterfly clips or designated storage device.

Actual Inventory:

PP-HELMET - PHONE TALKER
MARK 4 MOD 0

NSN 8470-01-127-7337

WT. 4.0 lbs.

VOL. 1,124.0 in³

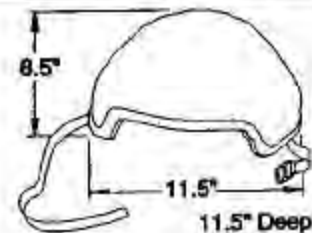

Helpful Hints: Stored in phone talker helmet rack in main DCRS or passageway.

Actual Inventory:

DCUL

Quantity
Required

PP-LANTERN HEAD - (USES FOUR SIZE AA BATTERIES)

NSN 6135-00-043-7845 SIZE AA BATTERIES
NSN 6230-01-285-4396 ASSEMBLY
PHILLIPS HPR-40 OR REPLACEMENT
OSRAM 640721 HALOGEN BULB

WT. 1.0 lbs VOL. 117.0 in³

Helpful Hints:

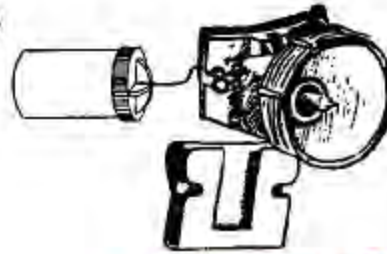

4

DELETE

Actual Inventory:

CP - MASK - MCU-2A/P

0000-LL-CQA-3202 (SELECT SIZE)

NSN 4240-01-327-4148
4240-01-327-4149
4240-01-327-4150

WT. 6.4 lbs VOL. 575.9 in³

Helpful Hints:

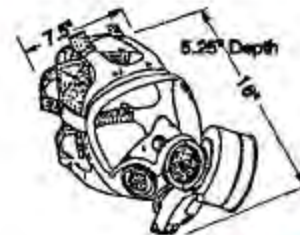

AR

DELETE

Actual Inventory:

PP-CANISTER - MCU 2/P (C-2) GREEN

NSN 4240-01-119-2315
(CAN OF 2)

WT. 0.8 lbs. VOL. 34.7 in³

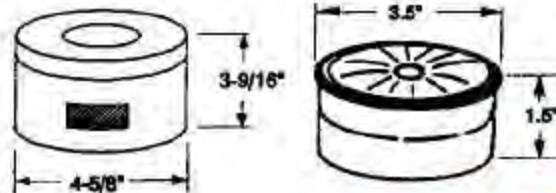

AR

Helpful Hints: Can be stowed in DCRS, CBR lockers, or CBR storeroom.

DELETE

Actual Inventory:

DCUL

Quantity
Required

CONNECTION - WYE GATE
2-1/2" NH INLET x TWO 1-1/2" NPSH OUTLETS

NSN 4210-00-255-0234

WT. 11.0 lbs. VOL. 185.9 in.³

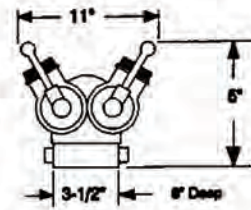

Helpful Hints:

Actual Inventory:

WRENCH - DECK DRAIN VALVE
(SIZE AS REQUIRED)

NSN 5120-00-030-2738

WT. 0.4 lbs VOL. 20.0 in.³

DELETE

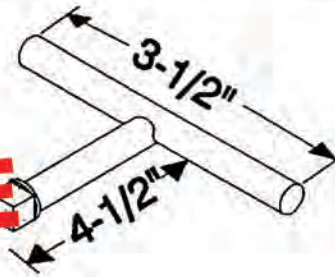

2

Helpful Hints:

Actual Inventory:

WRENCH - MONKEY 21"

NSN 5120-00-277-9089

WT. 10.0 lbs. VOL. 138.6 in.³

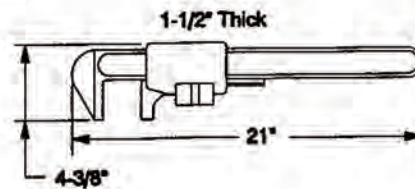

2

Helpful Hints:

Actual Inventory:

DCUL

Quantity
Required

WRENCH - SPANNER
3/4" TO 2"

NSN 5120-00-288-8746

WT. 1.3 lbs **VOL.** 3.0 in³

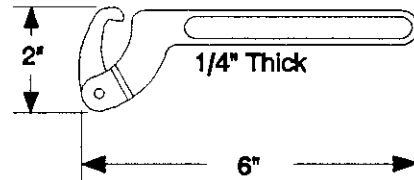

2

Helpful Hints:

Actual Inventory:

WRENCH - SPANNER
ADJUSTABLE HOOK WITH FIXED PIVOT
RANGE FROM 2" TO 4-3/4"

NSN 5120-00-277-9076

WT. 2.0 lbs. **VOL.** 6.7 in.³

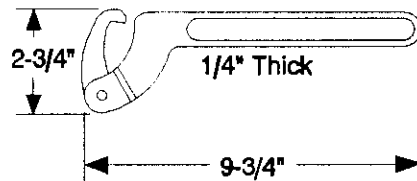

2

Helpful Hints:

Actual Inventory:

DAMAGE CONTROL UNIT PATROL STATION (DCUPS)

AEL Range: 2-880044216 to 4217

Utilize onboard material to build this kit. A laminated inventory list should be provided with this kit.

DCUPS

Quantity
Required

BATTERY D CELL 1.5 VOLT

NSN: 6135-00-835-7210

WT. 0.5 lbs

VOL. 3.0 in³

DELETE

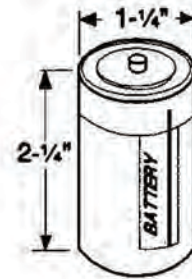

1
pkg

Helpful Hints:

Actual Inventory:

BAG-KIT -

NSN 8460-00-606-8366

WT. 2.3 lbs

VOL. 5.30 in³

DELETE

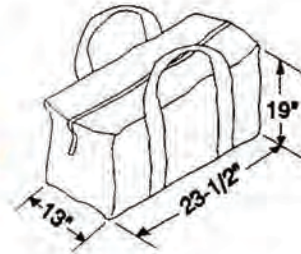

2

Helpful Hints: Replacement item. Utilize existing bags.

Actual Inventory:

BAR - WRECKING - 24"

STOCK DIA 3/4"

NSN 5120-00-224-1393

WT. 5.0 lbs

VOL. 1.5 in³

DELETE



1

Helpful Hints: Replacement item. Utilize existing bags.

Actual Inventory:

CHEST TOOL KIT - 23" x 9" x 11"

NSN 5140-00-369-4927

WT. 6.0 lbs.

VOL. 2.7 in³

DELETE

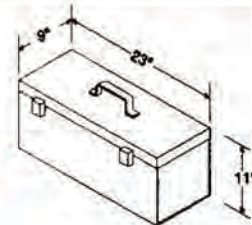

2

Helpful Hints: Utilize box or bag of approximate size as substitute.

Actual Inventory:

DCUPS

Quantity
Required

CLAMP SPRING - SMK CTN

9Q 5120-01-121-5023

WT. 6.0 oz

VOL. 29.1 in³

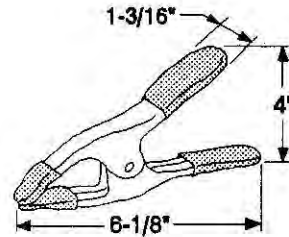

32

Helpful Hints:

Additional clamp added to better secure curtain. NAVSEA funds not required. Local purchase suggested (Adjustable Clamp, Chicago, IL)

Actual Inventory:

CONNECTION - WYE GATE
2-1/2" INLET x TWO 1-1/2" OUTLETS

NSN 4210-00-255-0234

WT. 11.0 lbs.

VOL. 185.9 in³

DELETE

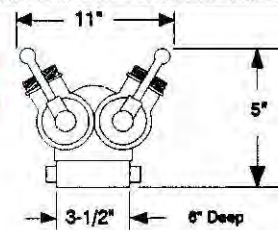

2

Helpful Hints:

Actual Inventory:

CP - MASK - MCU-2A/P

0000-LL-CQA-3202 (SELECT SIZE)

NSN 4240-01-327-4148

4240-01-327-4149

4240-01-327-4150

WT. 6.4 lbs

VOL. 575.9 in³

DELETE

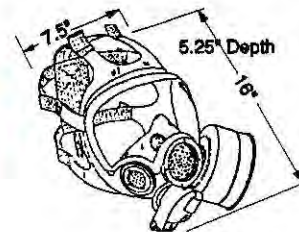

AR

Helpful Hints:

Actual Inventory:

PP-CANISTER - MCU 2/P (C-2) GREEN

NSN 4240-01-119-2315

(CAN OF 2)

WT. 0.8 lbs.

VOL. 34.7 in³

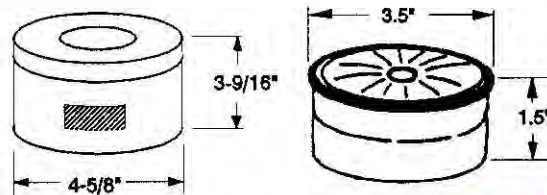

AR

Helpful Hints: Can be stowed in DCRS, CBR lockers, or CBR storeroom.

DELETE

Actual Inventory:

DCUPS

Quantity
Required

DECON KIT - M291
SKIN DECON

NSN 4230-01-276-1905

WT. 3.2 oz

VOL. 9. i

DELETE



AR

Helpful Hints:

Stored with MCU-2/P mask. Stowed in DCRS, CBR locker or CBR storeroom.
Allowance is 138% SMD or 1 box of 20 kits per 14%. Includes 33% SMD or 1 skin decon kit per 3 personnel for annual training.- M291

Actual Inventory:

FLASHLIGHT - WATERPROOF
WITHOUT "D" CELL BATTERIES
WITH 2 LAMPS, 1 SPOT AND 1 DIFFUSING.
2 FILTERS, 1 BLACKOUT AND 1 RED LENS.

NSN 6230-00-270-5418

WT. 3.0 oz

VOL. 3. i

DELETE

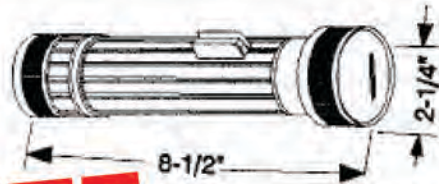

6

Helpful Hints:

Actual Inventory:

HAMMER - BLACKSMITH SLEDGE
12 LB.
CROSSPEEN HEAD
34 IN. HANDLE-HICKORY

NSN 5120-00-224-4130

WT. 14.0 lbs.

VOL. 678.1 in.³



1

Helpful Hints:

Actual Inventory:

FLASHLIGHT - INVESTIGATOR

NSN 6230-01-281-3775

WT. 1.5 lbs

VOL. 62.5 in³



6

Helpful Hints: Two per DCRS. Stow with Investigator's Kit.

Actual Inventory:

DCUPS

Quantity
Required

HOSE - 2-1/2" x 50 FT.
NON-METALLIC

NSN 4210-01-131-0247

WT. 35.0 lbs.

VOL. 1.8 0 in³

DELETE

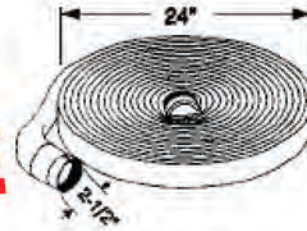

2

Helpful Hints:

Actual Inventory:

KIT - COLLECTIVE PROTECTION SYS

DELETE

1

This kit identifies all equipment used for the function of providing temporary CPS integrity. Individual items are listed on AEL #2-880044235 and in alphabetical order in this guide

KIT - ELECTRICAL REPAIR-DC

1H 0000-LL-CQA-2449

1

Used in damage control repair stations by qualified repair party electricians, this kit identifies all equipment used for the function of providing repairs to electrical panels, lighting, wireways and portable electrical equipment.

KIT - EMERGENCY COMM-DC

1H 0000-LL-CQA-2451

1

This kit identifies all equipment used for the function of providing emergency communications at battle stations or other general shipboard casualties.

KIT - FIRE FIGHTING/ACCESS
EQUIPMENT-DC

1

1H 0000-LL-CQA-2454

This kit identifies all equipment used for the function of providing access into compartments/spaces and combating fires. Individual items are listed on AEL #2-880044252 and in alphabetical order in this guide.

DCUPS

Quantity
Required

KIT - FIRST AID

NSN 6545-00-116-1410

WT. 10.0 lbs. VOL. 26.9 in³

Helpful Hints:

A laminated kit inventory should be with this kit.

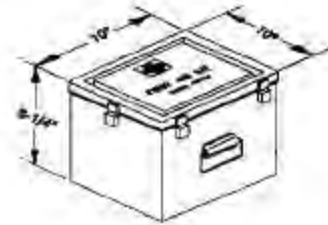

1

Actual Inventory:

KIT - INVESTIGATOR - DC

1H 0000-LL-CQA-2457

This kit identifies all equipment used for the function of performing the preliminary survey of a known or suspected damage/fire/flooding area. Individual items are listed on AEL #2-880044262 and in alphabetical order in this guide.

1

**LANTERN - ELECTRIC (FLOOD SEAL BEAM)
WET CELL, DAMAGE CONTROL FLOOD TYPE.**

NSN 6230-00-643-3661

WT. 4.0 lbs. VOL. 919.80 in³

DELETE

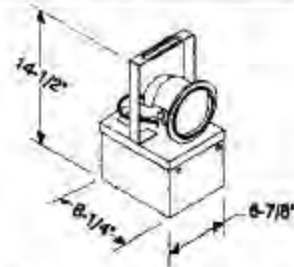

1

Helpful Hints: U.S.S Stark Lessons Learned item. Recommend stowing on rubber mat to prevent battery drainage. Kit - Battery Conversion 1HM0099-LL-H40-4396. See AEL 2-880044298.

Actual Inventory:

DCUPS

Quantity
Required

PP-BOOTS - FIREMAN

1H 0000-LL-CJ6-8462 SELECT SIZE

- NSN 8430-00-753-5935 SIZE 05
- NSN 8430-00-753-5936 SIZE 06
- NSN 8430-00-753-5937 SIZE 07
- NSN 8430-00-753-5938 SIZE 08
- NSN 8430-00-753-5939 SIZE 09
- NSN 8430-00-753-5940 SIZE 10
- NSN 8430-00-753-5941 SIZE 11
- NSN 8430-00-753-5942 SIZE 12
- NSN 8430-00-753-5943 SIZE 13
- NSN 8430-00-753-5944 SIZE 14
- NSN 8430-00-753-5945 SIZE 15

(PAIR)

WT. 6.7 lbs

VOL. 3,935.2 in³

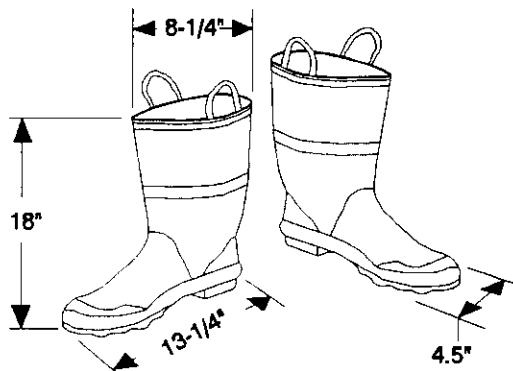

6

Helpful Hints: Each OBA should have boots available. Can be stowed with OBAs or in DCRS. Fireman boots are authorized for use by Repair Party Electricians (Nov 86 NAVSHIPS Safety Bulletin).

Actual Inventory:

PP-COVERALLS - - FIRE RET

MENS

1H 0000-LL-CJA-1091 (SELECT SIZE)

- NSN 8405-01-204-5397 SIZE 36S
- NSN 8405-01-204-5398 SIZE 36R
- NSN 8405-01-204-5399 SIZE 38S
- NSN 8405-01-204-5400 SIZE 38R
- NSN 8405-01-204-5401 SIZE 38L
- NSN 8405-01-204-5402 SIZE 40S
- NSN 8405-01-204-5403 SIZE 40R
- NSN 8405-01-204-5404 SIZE 40L
- NSN 8405-01-204-5405 SIZE 42S
- NSN 8405-01-204-5406 SIZE 42R
- NSN 8405-01-204-5407 SIZE 42L
- NSN 8405-01-204-5408 SIZE 44S
- NSN 8405-01-204-5409 SIZE 44R
- NSN 8405-01-204-5410 SIZE 44L

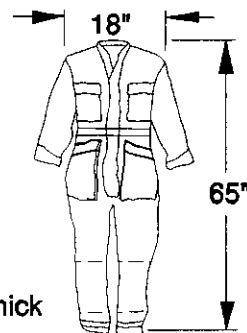

1/8" Thick

- NSN 8405-01-204-5411 SIZE 46S
- NSN 8405-01-204-5412 SIZE 46R
- NSN 8405-01-204-5413 SIZE 46L
- NSN 8405-01-204-5414 SIZE 48S
- NSN 8405-01-204-5415 SIZE 48L

6

WT. AVG 1.0 LB

VOL. AVG 108.0 in³ (FOLDED 18"X12"X1/2")

Actual Inventory:

DCUPS

Quantity
Required

PP - COVER - LENS OBA

NSN 4240-01-052-9901

WT. 0.2 lbs.

VOL. 5.0 in.³

DELETE

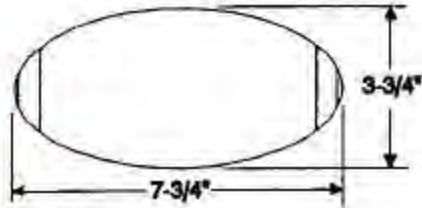

1
each

Helpful Hints: 25 per package.

Actual Inventory:

PP-GLOVES - ANTIFLASH

NSN 8415-01-267-9661

(PAIR)

WT. 1.0 oz

VOL. 11.3 in.³

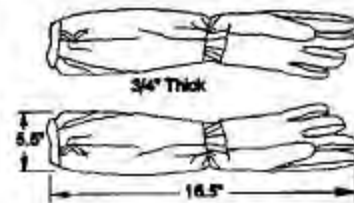

12

Helpful Hints:

Stored with life preserver and antiflash hood. Part of G.Q. gear.

Actual Inventory:

PP-GLOVES - RUBBER
7500 VOLT

NSN 8415-01-158-9450

(PAIR)

WT. 1.0 lb

VOL. 77.0 in.³

DELETE

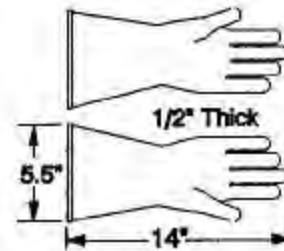

1
pair

Helpful Hints: Previous safety requirement.

Actual Inventory:

PP-GLOVES - SHELL ELEC

NSN 8415-00-264-3618

(PAIR)

WT. 1.5 lbs

VOL. 84.0 in.³

DELETE

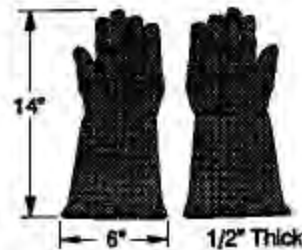

1
pair

Helpful Hints: Previous safety requirement.

Actual Inventory:

DCUPS

Quantity
Required

PP-GLOVES - FIREMAN

1HM0000-LL-CQA-2201 SELECT SIZE
NSN 8415-01-421-1368 SIZE SML
NSN 8415-01-421-1371 SIZE MED
NSN 8415-01-421-1373 SIZE LRG
NSN 8415-01-421-1375 SIZE X-LRG
NSN 8415-01-421-1376 SIZE XX-LRG
(PAIR)

WT. 2.0 lbs.

VOL. 108.0 in³

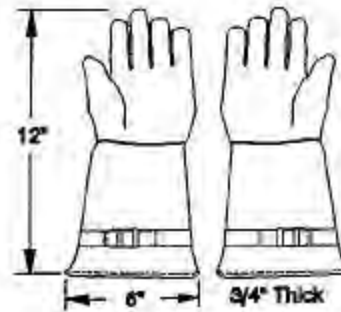

6
pair

Helpful Hints: Used for each OBA. Replace stock when worn with new firefighter's glove which has an aluminized back & knit wristlet. NSN: 8415-01-335-7901 (XS) thru 8415-01-335-7905 (XL).

Actual Inventory:

PP-HELMET - BATTLE

1HS0000-LL-CJ7-5888

WT. 3.0 lbs

VOL. 1,025.4 in³

Helpful Hints:

DELETE



AR

Actual Inventory:

PP-HELMET - FIREMAN

NSN 8415-01-271-8069

WT. 2.9 lbs

VOL. 1,320.0 in³



Helpful Hints: Stored in helmet rack in passageway, on hook, butterfly clips or designated stowage device.

Actual Inventory:

DCUPS

Quantity
Required

PP-HELMET - PHONE TALKER
MARK 4 MOD 0

NSN 8470-01-127-7337

WT. 4.0 lbs. VOL. 1,124.0 in³

DELETE

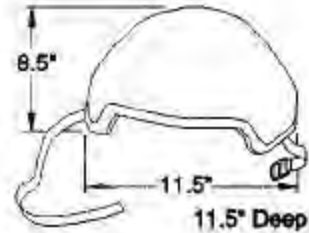

1

Helpful Hints: Stored in phone talker helmet rack in main DCRS or passageway.

Actual Inventory:

PP-HOOD - ANTIFLASH

NSN 8415-01-268-3473

WT. 2.0 oz VOL. 20.2 in³



12

Helpful Hints:

Actual Inventory:

PP-LANTERN HEAD - (USES FOUR SIZE AA BATTERIES)

NSN 6135-00-043-7845 SIZE AA BATTERIES
NSN 6230-01-285-4396 ASSEMBLY
PHILLIPS HPR-40 OR REPLACEMENT
OSRAM 640721 HALOGEN BULB

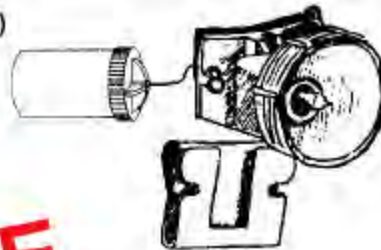

6

WT. 1.0 lbs VOL. 117.0 in³

DELETE

Helpful Hints:

Actual Inventory:

DCUPS

Quantity
Required

PP-LIFE PRESVR - Y INFLAT

NSN 4220-00-289-1891

WT. 3.0 lbs.

VOL. 60.0 in³

DELETE

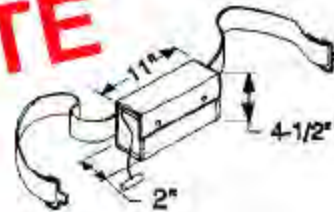

12

Helpful Hints: Stow with antifeash hood/gloves. Part of G.Q. gear.

Actual Inventory:

SMOKE CRTNS - TWO-PANEL CURTAIN
(STOWED FOLDED)

NSN 4210-01-306-7826

(3 SETS PER DCRS)

WT. 13.8 lbs.

VOL. 4,224.0 in³



4

Helpful Hints:

Actual Inventory:

TAPE - MEAS SOUNDING
50 FT

NSN 5120-00-221-1886

WT. 2.0 lbs.

VOL. 69.5 in³

DELETE

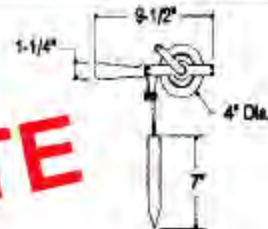

1

Helpful Hints:

Actual Inventory:

DCUPS

Quantity
Required

**WRENCH - MONKEY
(ADJUSTABLE AUTO)
15" LONG - ADJUSTABLE TO 3-5/8"
OPENING
STEEL**

NSN 5120-00-264-3793

WT. 3.5 lbs.

VOL. 67.5 in.³

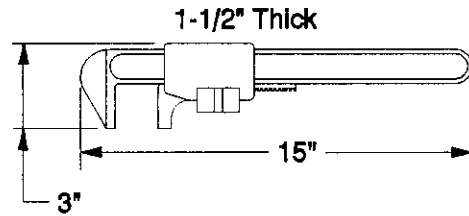

2

Helpful Hints:

Actual Inventory:

RESCUE AND ASSISTANCE / REENTRY LOCKER - DC

AEL Range: 2-880044218

Utilize onboard material to build this kit. A laminated inventory list should be provided with this kit. Use AEL-2-880044218 to verify quantity for specific ship class.

R & A / REENTRY LOCKER

Quantity
Required

BLANKET - BED GY 60" x 84"

NSN 7210-00-082-5668

WT. 3.0 lbs

VOL. 640.0 in³

Helpful Hints:

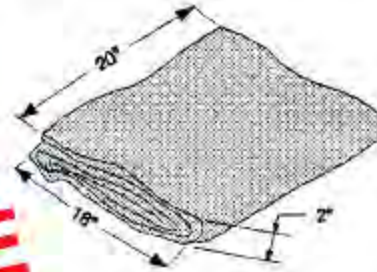

DELETE

QAR

Actual Inventory:

**EXTINGUISHER - FIRE
CO₂ 15 LB. PORTABLE
SHIPBOARD USE.**

NSN 4210-00-203-0217

WT. 50.0 lbs.

VOL. 3000.0 in.³

Helpful Hints: Non-magnetic extinguisher - optional for M-type ships.

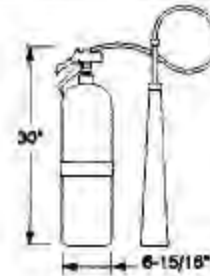

QAR

It should be relocated to passageway to provide immediate access to repair party personnel.
PMS due date _____

Actual Inventory:

**EXTINGUISHER - FIRE
PKP - 18 LB. PORTABLE
MAGNETIC**

NSN 4210-00-989-4589

WT. 52.5 lbs.

VOL. 3.632.8 in.³

Helpful Hints: Non-magnetic extinguisher - optional for M-type ships.

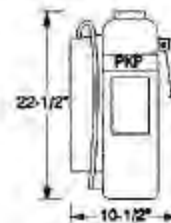

QAR

It should be relocated to passageway to provide immediate access for Repair Party Personnel.
PMS due date _____

Actual Inventory:

R & A / REENTRY LOCKER

Quantity
Required

**FLAGS - COMMUNICATION
PROVIDED BY OPS DEPT
(RESCUE & ASSISTANCE)**

NSN 8345-00-946-7899

WT. 0.5 lbs.

VOL. 20.0 in³

DELETE



QAR

Helpful Hints:

It should be relocated to passageway to provide immediate access for Repair Party Personnel.
PMS due date _____

Actual Inventory:

KIT - DESMOKING EQUIPMENT

1H 0000-LL-CQA-2446

QAR

This kit identifies all equipment used for the function of conducting desmoking operations during and after a fire. Individual items are listed on AEL #2-880044238.

KIT - DEWATERING EQUIPMENT

1HM 0000-LL-CQA-2447

QAR

This kit identifies all equipment used for the function of conducting dewatering operations during and after flooding or firefighting. Individual items are listed on AEL #2-880044240.

KIT - ELECTRICAL REPAIR-DC

1H 0000-LL-CQA-2449

QAR

Used in damage control repair stations by qualified repair party electricians, this kit identifies all equipment used for the function of providing repairs to electrical panels, lighting, wireways and portable electrical equipment. Individual items are listed on AEL #2-880044244.

KIT - EMERGENCY COMM-DC

1H 0000-LL-CQA-2451

QAR

This kit identifies all equipment used for the function of providing emergency communications at battle stations or other general shipboard casualties. Individual items are listed on AEL #2-880044246.

R & A / REENTRY LOCKER

Quantity
Required

KIT - EMERGENCY LIGHTING - DC

QAR

1H 0000-LL-CQA-2452

This kit identifies all equipment used for the function of providing extension cables and lights where power supply has been interrupted. This is used during shipboard casualties and Condition 1. Individual items are listed on AEL #2-880044248.

KIT - FIRE FIGHTING/ACCESS
EQUIPMENT-DC

QAR

1H 0000-LL-CQA-2454

This kit identifies all equipment used for the function of providing access to fire areas. Individual items are listed on AEL #2-880044252.

KIT - FIRE FIGHTING/ACCESS
PERSONNEL - DC

QAR

1H 0000-LL-CQA-2455

This kit identifies all equipment used for the function of providing personnel protection to the fire fighter. Individual items are listed on AEL #2-880044254.

KIT - FIRST AID

NSN 6545-00-116-1410

WT. 10.0 lbs. VOL. 26.9 in³

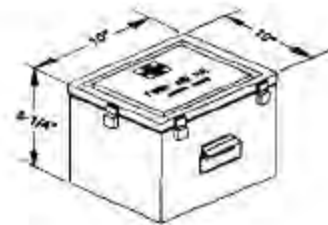

QAR

Helpful Hints:

A laminated kit inventory should be with this kit.

Actual Inventory:

KIT - GAS FREE ENGINEER-DC

1H 0000-LL-CQA-2456

This kit identifies all equipment used for the function of detecting the presence of poisonous and volatile fumes and gas, and to determine oxygen deficiency in a given compartment. Individual items are listed on AEL #2-880044260.

Actual Inventory:

DELETE

R & A / REENTRY LOCKER

Quantity
Required

KIT - INVESTIGATOR - DC

1H 0000-LL-CQA-2457

QAR

This kit identifies all equipment used for the function of performing the preliminary survey of a known or suspected damage/fire/flooding area. Individual items are listed on AEL #2-880044262.

KIT - LOW PRESSURE BOUNDARY COOLING-DC

1H 0000-LL-CQA-2458

DELETE

QAR

This kit identifies all equipment used for the function of boundary cooling. Individual items are listed on AEL #2-880044264. AEL number replaces deleted L.P. Air Line Jumper Kit.

KIT - PORTABLE PUMP
ACCESSORIES-DC

1H 0000-LL-CQA-2460

QAR

This kit identifies all equipment used for the function of providing accessories to the P-100 pumps to function as a dewatering/fire fighting pump. Individual items are listed on AEL #2-880044268.

KIT - PIPE PATCHING-DC

1HM0000-LL-CQA-0095

QAR

This kit identifies all equipment used for the function of providing emergency pipe repair on L.P. systems. Individual items are listed on AEL #2-880044268.

KIT - PLUGGING-DC

1HM0000-LL-CQA-0102

QAR

This kit identifies all equipment used for the function of providing emergency hull/bulkhead plugging repair and split seam repair caulking. Individual items are listed on AEL #2-880044272.

R & A / REENTRY LOCKER

Quantity
Required

**KIT - PORTABLE EXOTHERMIC
CUTTING UNIT (PECU)-DC**

QAR

NSN 4240-01-272-3841

The PECU will replace existing portable oxyacetylene cutting units on a one for one basis. The PECU will provide for more rapid access into areas of the ship where normal access is impaired for fire fighting operations, and to drain accumulated firefighting water from areas of the ship where the effects of the accumulated firefighting water will impair the ship's stability. The PECU utilizes expendable cutting rods which operate on the exothermic torch principle. This principle involves the use of oxygen which is combined with a fuel. In this case the fuel is a steel tube. The exothermic cutting rod is ignited when the oxygen passing through the iron rod comes in contact with a spark generated from a 12 volt DC battery powered igniter. This kit identifies all equipment used for the function of cutting through ferrous and non-ferrous wiring and other shipboard materials, particularly aircraft carrier flight decks. Individual items are listed on AEL #2-880044274.

Helpful Hints:

KIT - RESCUE AND ASSIST-DC

QAR

1H 0000-LL-CQA-2464

This kit identifies all equipment used for the function of providing off ship assistance at sea or in port to conduct fire fighting, dewatering or personnel rescue operations. Individual items are listed on AEL #2-880044279.

**LIGHT - HAND HELD
(SIGNAL)**

NSN 5850-00-501-1455

WT. 3.0 lbs.

VOL. 386.4 in³

DELETE

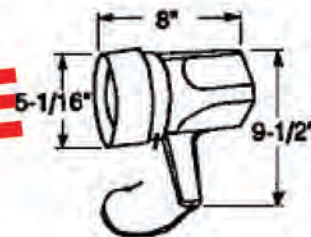

QAR

Helpful Hints: Provided by Operations Dept.

LITTER - RIGID, STOKES

NSN 6530-01-315-4784

WT. 34.0 lbs.

VOL. 119.0 in³

DELETE

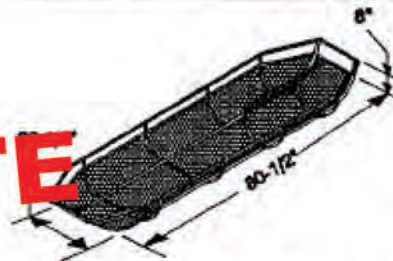

QAR

Helpful Hints: Provided by Medical Dept.

R & A / REENTRY LOCKER

Quantity
Required

PISTOL - VARY

NSN 1095-00-726-5820

WT. 2.0 lbs.

VOL. 84.0 in³

DELETE



QAR

Helpful Hints: Provided by Weapons Dept.



PP-BOOTS - FIREMAN

1H 0000-LL-CJ6-8462

SELECT SIZE

NSN 8430-00-753-5935

SIZE 05

NSN 8430-00-753-5936

SIZE 06

NSN 8430-00-753-5937

SIZE 07

NSN 8430-00-753-5938

SIZE 08

NSN 8430-00-753-5939

SIZE 09

NSN 8430-00-753-5940

SIZE 10

NSN 8430-00-753-5941

SIZE 11

NSN 8430-00-753-5942

SIZE 12

NSN 8430-00-753-5943

SIZE 13

NSN 8430-00-753-5944

SIZE 14

NSN 8430-00-753-5945

SIZE 15

(PAIR)

WT. 6.7 lbs

VOL. 3,935.2 in³

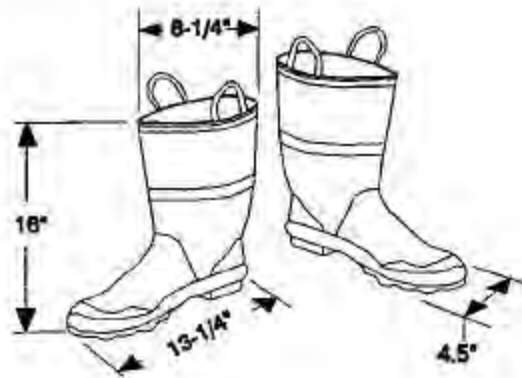

Helpful Hints: Each OBA should have boots available. Can be stowed with OBAs or in DCRS. Fireman boots are authorized for use by Repair Party Electricians (Nov 86 NAVSHIPS Safety Bulletin).

Actual Inventory:

R & A / REENTRY LOCKER

Quantity
Required

PP-BREATHING APPARAT - A-4

NSN 4240-00-616-2857

WT. 15.5 lbs

VOL. 3,366.0 in³

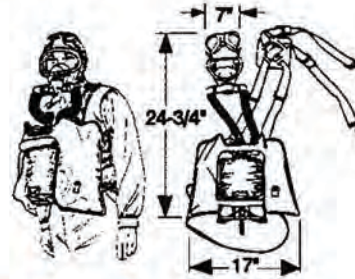

QAR

Add SCBA Note

Helpful Hints: PP-COVER-LENS for OBA face piece (NSN 4240-01-052-9901) 1 package required. PP-WRENCH, SPANNER (NSN 5120-01-290-1804) for OBA, used to remove valve cap for replacing diaphragms and gaskets. Delete OBA requirements when ship is outfitted with SCBA

Actual Inventory:

PP-CANISTER - OXYGEN GEN
(GREEN)

NSN 4240-00-174-1365

(BOX OF 6 CANISTERS)

WT. 4.0 lbs

VOL. 178.1 in³



QAR

Add SCBA Note

Helpful Hints: Allowance of canisters for all ships is twelve each for one breathing apparatus, six as ready service and six as reserve. Ready service canisters shall be stowed with their respective OBAs. Reserve canisters shall be stowed in repair stations, weather access reentry stowage spaces or other readily accessible locations on or above the damage control deck as approved by the supervisor. Reserve canisters may be stowed in their original shipping containers. Canisters for shipboard use must be equipped with A2 pc cap. Delete OBA requirements when ship is outfitted with SCBA.

Actual Inventory:

R & A / REENTRY LOCKER

Quantity
Required

PP-COVERALLS - - FIRE RET

MENS

1H 0000-LL-CJA-1091 (SELECT SIZE)

NSN 8405-01-286-6336 SIZE 36S

NSN 8405-01-286-6337 SIZE 36R

NSN 8405-01-286-6338 SIZE 38S

NSN 8405-01-286-6339 SIZE 38R

NSN 8405-01-286-6340 SIZE 38L

NSN 8405-01-286-6341 SIZE 40S

NSN 8405-01-286-6342 SIZE 40R

NSN 8405-01-286-6343 SIZE 40L

NSN 8405-01-286-6344 SIZE 42S

NSN 8405-01-286-6345 SIZE 42R

NSN 8405-01-286-6346 SIZE 42L

NSN 8405-01-286-6347 SIZE 44S

NSN 8405-01-286-6348 SIZE 44R

NSN 8405-01-286-6349 SIZE 44L

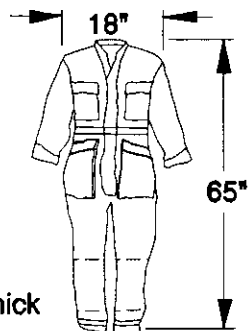

1/8" Thick

QAR

NSN 8405-01-286-6350 SIZE 46S

NSN 8405-01-286-6351 SIZE 46R

NSN 8405-01-286-6352 SIZE 46L

NSN 8405-01-286-6353 SIZE 48S

NSN 8405-01-286-6354 SIZE 48R

WT. AVG 1.0 LB

VOL. AVG 108.0 in³ (FOLDED 18"X12"X½")

Actual Inventory:

PP-GLOVES - ANTIFLASH

NSN 8415-01-267-9661

(PAIR)

WT. 1.0 oz

VOL. 11.3 in³

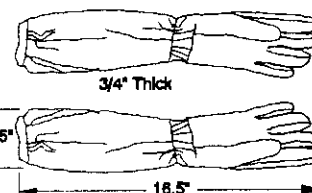

3/4" Thick

5.5"

18.5"

QAR

Helpful Hints:

Stored with life preserver.

Actual Inventory:

R & A / REENTRY LOCKER

Quantity
Required

PP-GLOVES - FIREMAN

1HM0000-LL-CQA-2201 SELECT SIZE
 NSN 8415-01-421-1368 SIZE SML
 NSN 8415-01-421-1371 SIZE MED
 NSN 8415-01-421-1373 SIZE LRG
 NSN 8415-01-421-1375 SIZE X-LRG
 NSN 8415-01-421-1376 SIZE XX-LRG
 (PAIR)

WT. 2.0 lbs.

VOL. 108.0 in³

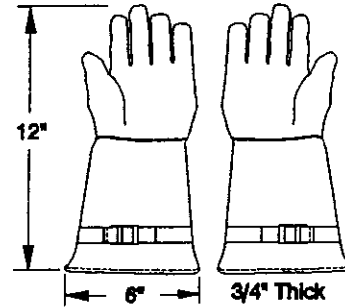

QAR

Helpful Hints: Used for each OBA. Replace stock when worn with new firefighter's glove which has an aluminized back & knit wristlet. NSN: 8415-01-335-7901 (XS) thru 8415-01-335-7905 (XL).

Actual Inventory:

PP-HELMET - FIREMAN

NSN 8415-01-271-8069

WT. 2.9 lbs

VOL. 1,320.0 in³

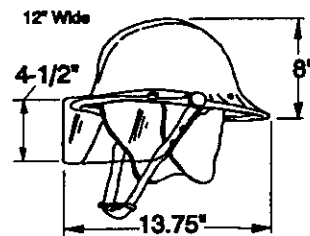

QAR

Helpful Hints: Stored in helmet rack in passageway, on hook, butterfly clips or designated stowage device.

Actual Inventory:

PP-HELMET - PHONE TALKER MARK 4 MOD 0

NSN 8470-01-127-7337

WT. 4.0 lbs.

VOL. 1,124.0 in³

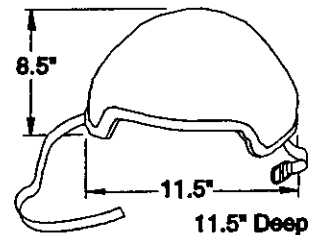

QAR

Helpful Hints: Stored in phone talker helmet rack in main DCRS or passageway.

Actual Inventory:

R & A / REENTRY LOCKER

Quantity
Required

PUMP - P-250 MOD 1

NSN 4320-01-186-3377

WT. 155.0 lbs

VOL. 10.8 cu in

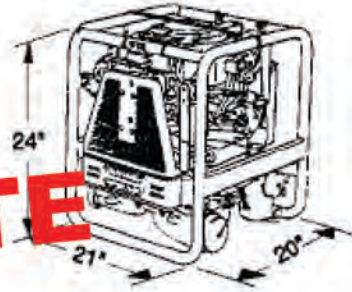

QAR

DELETE

Helpful Hints: APL - 2-470004085 P-250 (mod 1) allowance
APL #017600005 P-250 unit repair parts (mod 1)
APL #017600006 P-250 pump end repair parts (mod 1)
APL #668200001 P-250 engine repair parts (mod 1)
APL #47000401516 P-250 accessories / eductor

Actual Inventory:

RADIO - PORTABLE

NSN 5820-00-857-0759

WT. 15.0 lbs

VOL. 43.0 cu in

DELETE

QAR

Helpful Hints: Provided by OPS Dept. (AN/PRC-25)

Actual Inventory:

R & A / REENTRY LOCKER

Quantity
Required

PUMP - P-250 MOD 1

NSN 4320-01-186-3377

DELETE

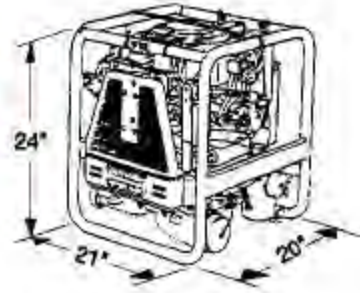

QAR

WT. 155.0 lbs

VOL. 10,080.0 in³

Helpful Hints: APL - 2-470004085 P-250 (mod 1) allowance
APL #017600005 P-250 unit repair parts (mod 1)
APL #017600006 P-250 pump end repair parts (mod 1)
APL #668200001 P-250 engine repair parts (mod 1)
APL #47000401516 P-250 accessories / eductor

Actual Inventory:

RADIO - PORTABLE

NSN 5820-00-857-0759

QAR

WT. 15.0 lbs

VOL. 432.0 in³

Helpful Hints: Provided by OPS Dept. (AN/PRC-25)

Actual Inventory:

SHORING SUPPLEMENT KIT

(MHC 51 Class Only)

AEL Range: 2-880044289

Utilize onboard material to build this kit. A laminated inventory list should be provided with this kit.

SHORING SUPPLEMENT KIT - DC

Quantity
Required

KIT, SHORING - SUPPLEMENT

1HS0000-LL-CQA-4178

1

This kit identifies all equipment used for the function of emergencies involving Glass Reinforced Plastic (GRP) repair as a shoring supplement on MHC 51 Class ships. Individual items are listed on AEL #2-880044289 and in alphabetical order in this guide.

BAG-KIT -

NSN 8460-00-606-8366

WT. 2.3 lbs

VOL. 5,804.5 in³

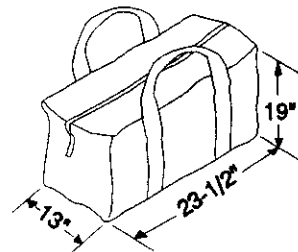

2

Helpful Hints: Used to stow/carry tools to scene for securing wedges backing plate/doubler plate and GRP repair.

Actual Inventory:

BIT-SET -

NSN 5120-01-372-4965

WT. 0.5 lbs

VOL. 20.0 in³

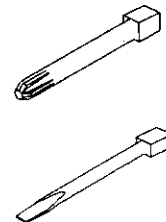

1
each

Helpful Hints: 1/4" square drive, 1/2" socket adapter, insert bits No. 1 and 2 Phillips, Nos. 6-8, 10-12 slotted: magnetic bit holder.

Actual Inventory:

SHORING SUPPLEMENT KIT - DC

Quantity
Required

DRILL, CORDLESS -

NSN 5120-01-236-9633

WT. 3.0 lbs VOL. 100.0 in³

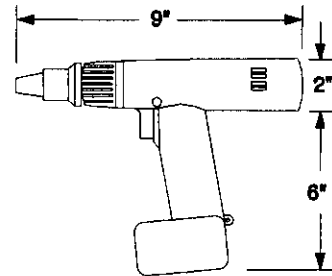

1

Helpful Hints: Removable energy pack, reversible, high torque. Used for drilling pilot holes, driving lag bolts and self tapping screws.

Actual Inventory:

LAG BOLT

NSN 5306-00-058-2971 (4" x .312") Qty - 1 box -
 5306-00-406-9232 (5" x .375") Qty - 1 box -
 5306-00-412-9786 (2-1/2" x .500") Qty - 20 each -

Pilot hole size

.242
.290
.390

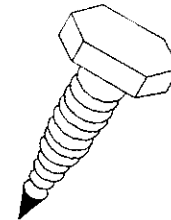

22

WT. lbs VOL. in³

Helpful Hints: U/I contins 50 per box for 4" and 5" steel phosphate coated lag bolts. Used for securing shoring strongbacks/backing plate.

Actual Inventory:

PLYWOOD

AA EXTERIOR - 96" x 48"

NSN 5530-00-129-7749 (3/8" x 24" x 24") illustrated
 5530-00-129-7833 (3/4" x 18" x 18")

WT. 35.0 lbs VOL. 1,728.0 in³ - 3/8"
 WT. 70.0 lbs VOL. 3,456.0 in³ - 3/4"

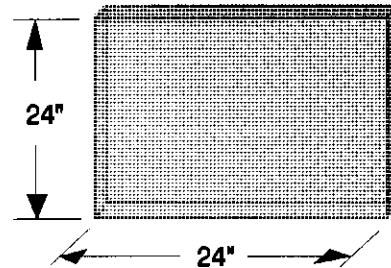

1 sht
each
size

Helpful Hints: Cut from 96" x 48" sheets. 3/8" is used for patches. Patch size generally will not exceed 24" x 24" or 8 patches total stowed in repair 2 or UPL. 3/4" is used for backing plate doubler plates. One sheet will provide 14 each 12" x 12" and 6 each 18" x 18" plates.

Actual Inventory:

SHORING SUPPLEMENT KIT - DC

Quantity
Required

REPAIR KIT
TYPE 1

1HM2090-00-372-6064

WT. 48.0 lbs

VOL. 1,716.0 in³

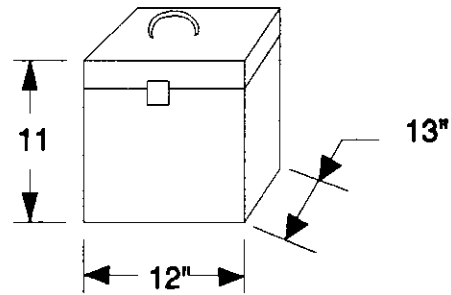

2

Helpful Hints: Used in GRP emergency repairs.

MIL-R-199070. Materials stowed in metal box. Stencil box GRP Repair Kit, Type 1 in 1/2" black letters.

ITEM	UNIT
1. Resin liquid	3 each, 24 fl oz. in 1 qt can
2. Resin liquid	3 each, 12 fl oz. in 1 pt can
3. Hardener, liquid	3 each, 1/2 pt container
4. Hardener, liquid	3 each, 1/4 pt container
5. Resin, paste	5 each, 60 CM ³
6. Hardener, paste	5 each collapsible tubes
7. Glass cloth	3 square yds
8. Woven roving cloth	5 square yds
9. Glass mat	6 square ft.
10. Polyethylene gloves	6 prs (3 med, 3 lg)
11. Separating film	4 square yds
12. Eye protection	1 each
13. Wooden spatula	10 each
14. Wooden stirring rods	5 each
15. Stirring spatula	5 each
16. Spreading tool	1 each
17. Brush, glue	4 each
18. Paper kraft wrapping	3 square yds
19. Sandpaper, aluminum oxide, 80 grit	2 sheets
20. Scissors	1 each
21. Instruction publication	1

Actual Inventory:

SHORING SUPPLEMENT KIT - DC

Quantity
Required

SCREW, SELF TAPPING

NSN 5305-01-023-5834

72



WT. 1.0 lbs

VOL. 30.0 in³

length = 1.45"

Helpful Hints: Used in securing steel shore foot and backing plates. 304 stainless, slot drive, flathead. Six required per steel shore foot.

Actual Inventory:

SAFETY / SURVIVABILITY NDI EQUIPMENT

AEL Range: 2-880044298 to 4299

This equipment will be outfitted as
NAVSEA funding is available.

NDI EQUIPMENT

Quantity
Required

ALARM - PERSONNEL ALERT

1HM0099-LL-H40-8967

WT. 0.6 lbs VOL. 21.7 in³

Helpful Hints: Five per ship. Stowage determined by gas free engineer. Weight includes battery, 9 volt.

DELETE

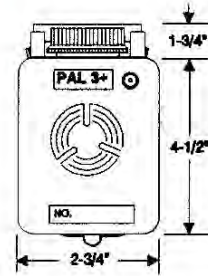

Actual Inventory:

AMPLIFIER - SOUND/POWERED PHONE

1HM0099-LL-H40-8968

WT. 0.5 lbs VOL. 18.0 in³

Helpful Hints: Two per DCRS. Stow with Emergency Communication Kit.

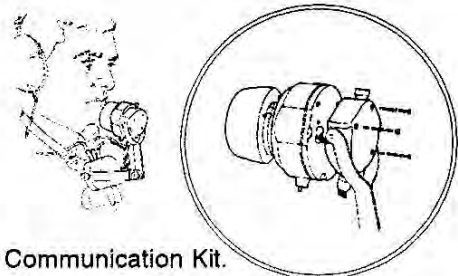

Actual Inventory:

ATTACHMENT - PORTABLE WATER BLOWER

1HM0099-LL-H40-8969

WT. 17.0 lbs VOL. 2,500.0 in³

Helpful Hints: One per DCRS. Stow with desmoking equipment.

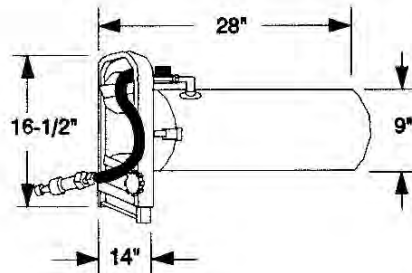

Actual Inventory:

CLAMP - DAMAGE CONTROLMAN

1HM0099-LL-H40-8970 - 1-1/2"
1HM0099-LL-H40-8971 - 2-1/2"

WT. 1.5 lbs VOL. 27.5 in³

Helpful Hints: One per DCRS. Stow within DCRS on a shelf or in a bin. Clamp up to 125 psi. The clamp has a spanner built into handle.

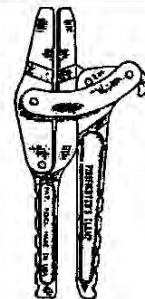

Actual Inventory:

NDI EQUIPMENT

Quantity
Required

DUCT - MANHOLE/SCUTTLE
SADDLE VENT

1HM0099-LL-H40-8972

WT. 8.0 lbs

VOL. 31.5 in³

DELETE



Helpful Hints: One per DCRS. Stow with desmoking equipment. A hatch bolt is used to secure vent saddle. Used with the 8" vent duct hose.

Actual Inventory:

FIREFINDER
SENSOR, PORTABLE INFRARED HEAT

NSN 4210-01-207-9687

WT. 2.0 lbs

VOL. 5.6 in³

DELETE



Helpful Hints: Two per DCRS. Stow with Investigator's Kit.

Actual Inventory:

FLASHLIGHT - INVESTIGATOR

NSN 6230-01-281-3775

WT. 1.5 lbs

VOL. 62.5 in³

DELETE



Helpful Hints: Two per DCRS. Stow with Investigator's Kit.

Actual Inventory:

NDI EQUIPMENT

Quantity
Required

FOUR GAS ANALYZER

1HM0099-LL-H40-8973

WT. 6.2 lbs

VOL. 5.6 in³

DELETE

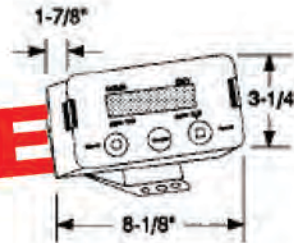

Helpful Hints: For gas free engineering. Stowage is determined by the gas free engineer. Ships with one DCRS will have one analyzer; Ships with two or three DCRSs will have two analyzers; Ships with four to eight DCRSs will have three analyzers.

Actual Inventory:

KIT - BATTERY CONVERSION LANTERN RECHARGEABLE

1HM0099-LL-H40-4396

WT. 2.0 lbs

VOL. 110.2 in³

DELETE

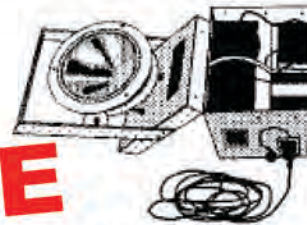

Helpful Hints: Two per DCRS. This provides a rechargeable power source for each emergency damage control lantern and is authorized as a replacement for current wet cell battery used in the lantern. The kit consists of three sealed rechargeable 6V AA batteries and one 110V AC charger module.

Actual Inventory:

KIT - PNEUMATIC RESCUE TOOL, AIRGUN 40

1HM0099-LL-H40-8975

WT. 31.0 lbs

VOL. 1,952.4 in³

DELETE

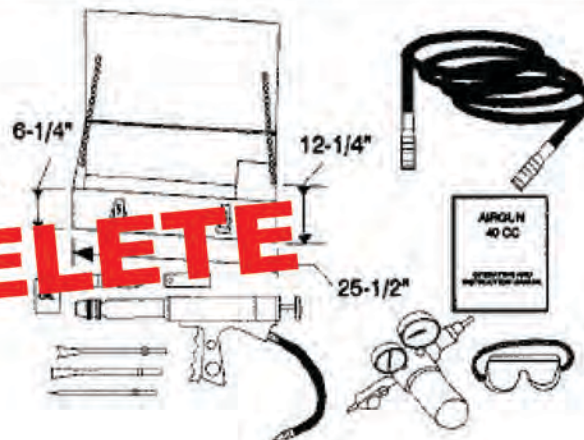

Helpful Hints: One per ship. Stow in Crash and Rescue Locker or in a DCRS.

Actual Inventory:

NDI EQUIPMENT

Quantity
Required

LADDER - FOLDING

1HM0099-LL-H40-8976

WT. 9.0 lbs VOL. 9,216.0 in³

DELETE

Helpful Hints: One per DCRS.
Stow with shoring or access equipment.

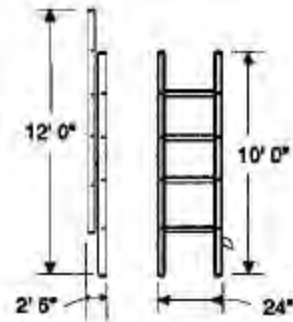

Actual Inventory:

POLE - MAN OVERBOARD RESCUE

1HM0099-LL-H40-8977

WT. lbs VOL. in³

DELETE

Helpful Hints: Two per ship. Stowage to be determined by the First Lieutenant.



Actual Inventory:

RESCUE DEVICE - CONFINED SPACE HAUL SAFE

1HM0099-LL-H40-8978

WT. 30.0 VOL. 1,728.0³

Helpful Hints: One per DCRS. Stow with access equipment.

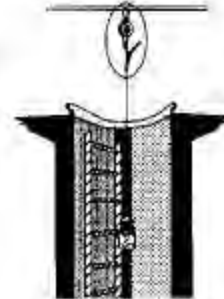

Actual Inventory:

NDI EQUIPMENT

Quantity
Required

THERMAL CUTTER - DIVER WORN
EMERGENCY ACCESS
KERIE CABLE

NSN 4220-01-359-0849

WT. 95.0 lbs VOL. 9,728.0 in³

DELETE

Helpful Hints: Only required on CV/CVN,
LHA, and LHD class ships.
Stowage to be determined by
the ship's DCA.

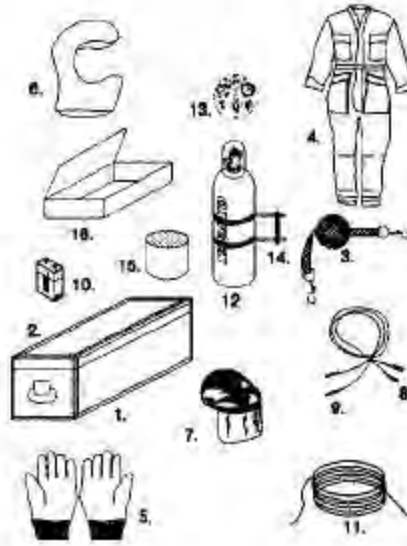

Actual Inventory:

**Will Be Removed
in Next Version**

**DELETED ITEMS
FROM DCRS EQUIPMENT**

DCAS & Inspection teams -
Ensure Equipment is removed
from Damage Control useage
and stowages to make stowage
space available for new
equipment enhancements.

DELETED ITEMS

Quantity
Required

BANDING KIT - CLAMPING TOOL - STRAP BAND-IT KIT.

1HS0000-LL-CHO-4115
NSN 5180-00-288-6567
NSN 5120-00-278-9925

WT. 3.0 lbs. VOL. 159.3 in.³

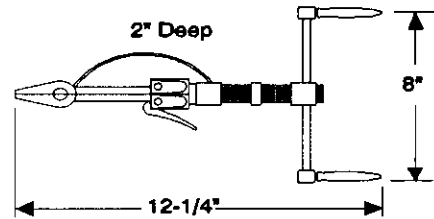

Helpful Hints: Deleted from Pipe Patching Kit.

BATTERY D CELL 1.5 VOLT

NSN: 6135-00-835-7210

WT. 0.5 lbs VOL. 3.5 in.³

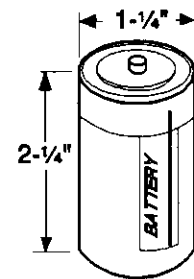

Helpful Hints: Deleted from Gas Free Engineering Kit.

BLOCK AND FALL - 8" DBL

NOTE: BLOCK & FALL CONSISTS OF TWO BLOCKS AND
ONE 300 FT LENGTH OF ROPE CUT FROM
1-3/4" NYLON ROPE LISTED BELOW

1H 0000-LL-CJ7-5879 (COMPLETE SYSTEM)
NSN 3940-00-926-3710 BLOCK,TACKLE
NSN 3940-00-926-3718 BLOCK,TACKLE 8IN DBL R1
NSN 4020-00-560-7732 ROPE-1-3/4 IN CRCM X 1200 FT

WT. 47.0 lbs. VOL. 5040.0 in.³

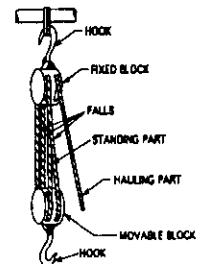

Helpful Hints: Deleted from Repair Locker Tool Kit.

DELETED ITEMS

Quantity
Required

CABLE - ASSEMBLY
CASUALTY POWER
75 FT

1HM0000-LL-CQA-0078

WT. 60.0 lbs **VOL.** 6,950.0 in³

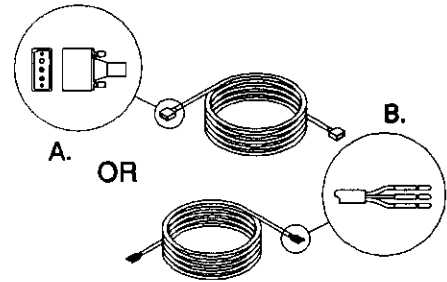

Helpful Hints: Deleted from AEL 2-880044201.

CASUALTY POWER - SWITCH
SYMBOL 1041
(FOR THREE PRONG CASUALTY POWER SYSTEM USEAGE ONLY)
NSN 5430-00-392-2894

WT. 15.0 lbs. **VOL.** 1,100.0 in³

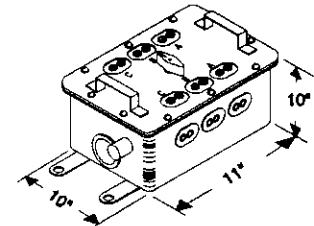

Helpful Hints: Deleted from all parent AELs.

CASUALTY POWER - WRENCH
(FOR THREE PRONG CASUALTY POWER SYSTEM USAGE ONLY)

NSN 5120-00-241-3181

WT. 0.4 lbs **VOL.** 4.6 in³

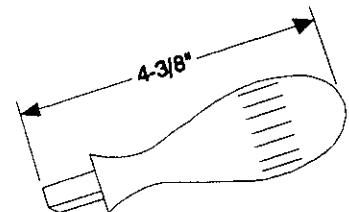

Helpful Hints: Deleted from AEL 2-880044201.

COUPLING - PNEUM
HALF QUICK 1/2"
CLASS-OF

NSN 4730-00-277-5680

WT. 0.2 lbs. **VOL.** 1.2 in.³

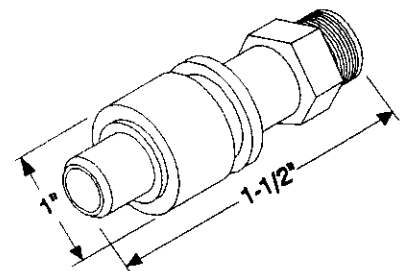

Helpful Hints: Previous requirement.
Deleted from Gas Free Engineer's Kit.

DELETED ITEMS

Quantity
Required

COUPLING - PNEUM
HALF QUICK 1/2"
CLASS-OM

NSN 4730-00-289-4242

WT. 0.2 lbs. **VOL.** 1.5 in.³

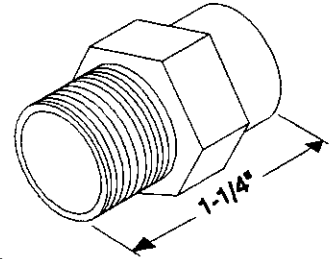

Helpful Hints: Previous requirement. Deleted from Gas Free Engineer's Kit.

COUPLING - STRAIGHT
1" X 1-43/64" - NPT

NSN 4210-00-187-7614

WT. 3.0 oz **VOL.** 1.3 in.³

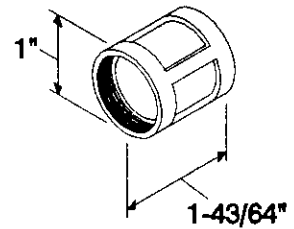

Helpful Hints:

COUPLING - STRAIGHT
2" X 2-17/32" - NPT

NSN 4210-00-187-7617

WT. 7.0 oz **VOL.** 7.9 in.³

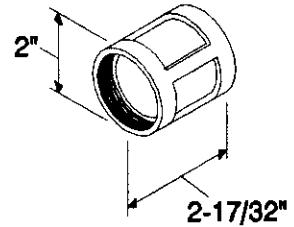

Helpful Hints:

COUPLING - STRAIGHT
2-1/2" X 2-7/8" - NPT

NSN 4210-00-187-7618

WT. 9.0 oz **VOL.** 14.1 in.³

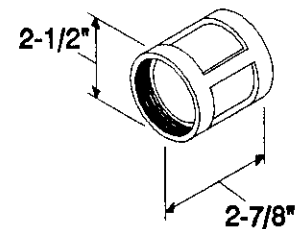

Helpful Hints:

DELETED ITEMS

Quantity
Required

DRILL - HAND, STRAIGHT SHANK,
NSN 5110-00-293-3411

WT. 2.5 lbs.

VOL. 412.5 in³

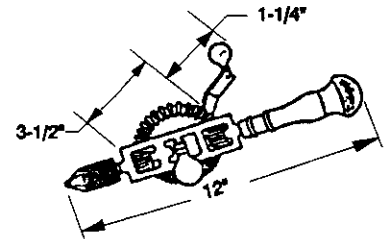

Helpful Hints: (Herty Gerty) Drills up to 3/8" hole. Previous requirement. Deleted from Repair Locker Tool Kit.

FAN - VANEAXIAL
RED DEVIL BLOWER
500 CFM - 110 VOLTS

NSN 4140-00-267-0967
NSN 4140-01-204-2799 INLET BELL W/SCREEN
NSN 4140-01-130-2354 NOSE CONE
NSN 4240-01-344-5368 DUCT BELL ASSY

WT. 109.0 lbs.

VOL. 5,510.8 in.³

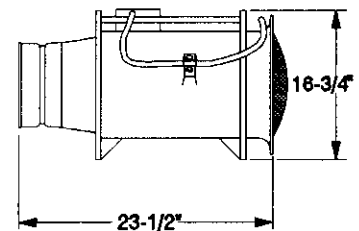

Helpful Hints: Deleted from AEL 2-880044200 (1 ea) and Desmoking Kit 2-880044238, 239 (2 ea).

FLEETPAK
(A pipe patching repair kit)

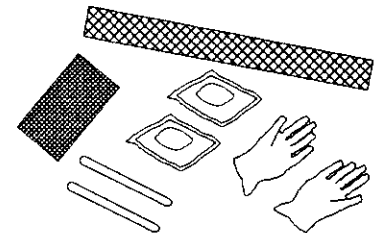

Helpful Hints: Deleted from NDI equipment.

DELETED ITEMS

Quantity
Required

FUSE - 5 AMP
250 VOLTS OR LESS
NSN 5920-00-280-4426

(BOX OF 10)
WT. 0.5 lbs

VOL. 12.1 in³

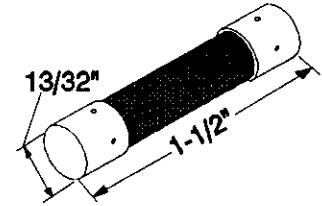
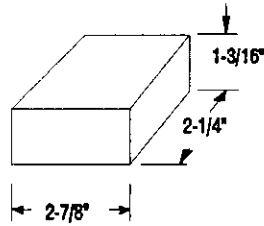

Helpful Hints:

FUSE - 5 AMP
250 VOLTS OR LESS
NSN 5920-00-503-4479

(BOX OF 10)
WT. 0.5 lbs

VOL. 12.1 in³

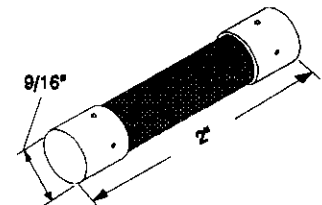
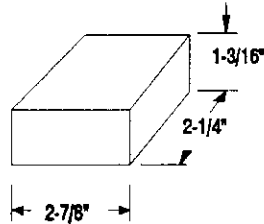

Helpful Hints: Deleted from Electrical Repair Kit.

FUSE - 10 AMP
250 VOLTS OR LESS
NSN 5920-00-280-4431

(BOX OF 10)
WT. 0.7 lbs

VOL. 12.1 in³

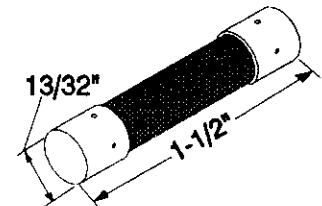
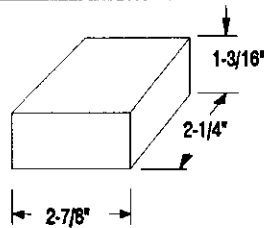

Helpful Hints: Deleted from Electrical Repair Kit.

DELETED ITEMS

Quantity
Required

FUSE - 15 AMP
125 VOLTS

NSN 5920-00-280-4428

(BOX OF 10)
WT. 0.4 lbs

VOL. 12.1 in³

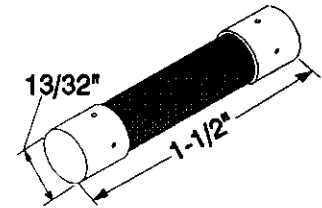
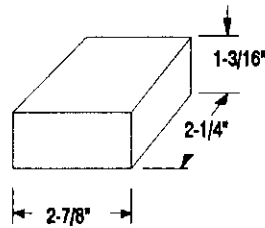

Helpful Hints: Deleted from Electrical Repair Kit.

FUSE - 30 AMP
250 VOLTS OR LESS

NSN 5920-00-849-6475

(BOX OF 10)
WT. 0.4 lbs

VOL. 12.1 in³

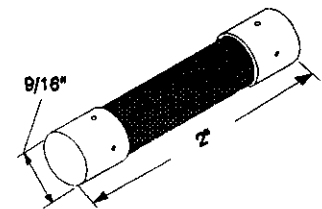
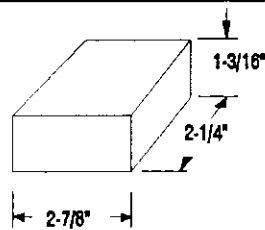

Helpful Hints: Deleted from Electrical Repair Kit.

FUSE - 15 AMP
125 VOLTS

NSN 5920-00-846-5727

(BOX OF 10)

WT. 0.4 lbs

VOL. 17.9 in³

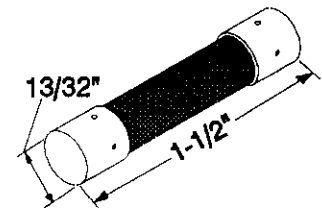
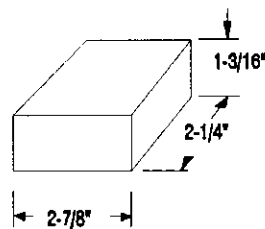

Helpful Hints: Deleted from Electrical Repair Kit.
Slow blow fuse used with the Red Devil Blower.

DELETED ITEMS

Quantity
Required

FUSE - CART

NSN 5920-00-851-4739
NSN 5920-00-853-0173

WT. 0.5 lbs VOL. 12.6 in³

Helpful Hints: Fuse cart contains 10 fuses. Deleted from Electrical Repair Kit.

GROUNDING CABLE - 6 FOOT

NSN 6150-01-147-0359

WT. 1.0 lbs VOL. 144.0 in³

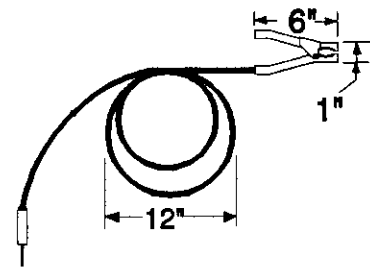

Helpful Hints: Safety requirement. Used to ground blowers during gas free evolutions. Deleted from Gas Free Engineering Kit.

HOIST, CHAIN 3 TON CAP

NSN 3950-00-965-0097

WT. 105.0 lbs VOL. 1,258.0 in³

Helpful Hints: Deleted from Repair Locker Tool Kit.

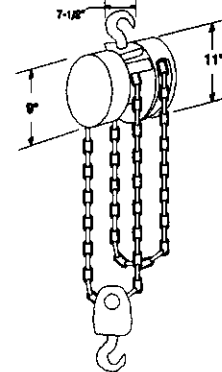

DELETED ITEMS

Quantity
Required

HOSE - AIR DUCT 8"-EXTENDS TO 15'
INTENDED FOR USE WITH PORTABLE
VENTILATING SETS ON SHIPS WHERE
NON-MAGNETIC EQUIPMENT IS NOT
REQUIRED.

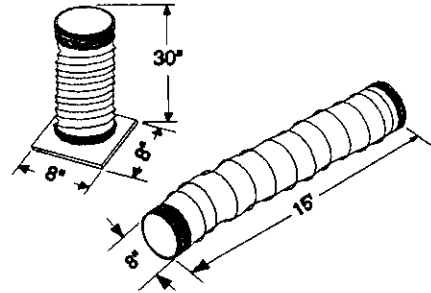

NSN 4720-00-277-7225

WT. 20.5 lbs. **VOL.** 3000.0 in.³

Helpful Hints: Vent duct for Red Devil Blower. Deleted from AEL 2-880044211 (4 each) and Desmoking Kit 2-880044238, 239 (4 each).

HOSE ASSEMBLY - PNEUMATIC
5/16" x 50 FT.

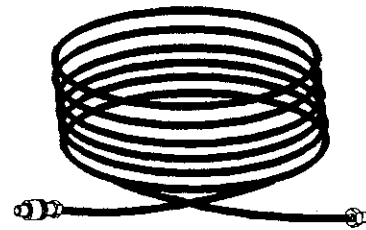

NSN 4720-00-293-7997

WT. 12.0 lbs **VOL.** 337.5 in.³

Helpful Hints: Previous requirement. Deleted from Gas Free Engineering Kit.

KIT - LOW PRESSURE AIR LINE-DC

1H 0000-LL-CQA-2458

This kit identifies all equipment used for the function of restoring L.P. air to vital and non-vital systems. Individual items are listed on AEL #2-880044264 and in alphabetical order in this guide.

KIT - PLASTIC PATCH-PIPE REPAIR

1HM0000-LL-CQA-0095

Helpful Hints: Deleted from all parent AELs except 2-880044200 and 2-880044201.

DELETED ITEMS

Quantity
Required

LAMB AIR MOVER -
3" MODEL 32119, 1640 CFM

NSN 4730-00-313-0680

WT. 6.5 lbs VOL. 2,521.0 in³

Helpful Hints: Deleted from Gas Free Engineering Kit.

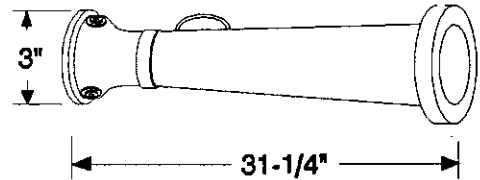

MASK - AIR LINE ASSEMBLY
TYPE 1 CLASS 2 WITH 25' OF 5/8"
AIRLINE HOSE
(AEL 2-88044047)

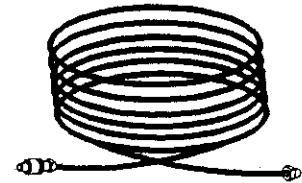
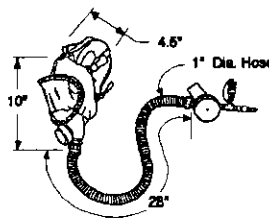

NSN 4240-00-040-8453 Filter
NSN 4240-00-275-3177 Airline Hose
NSN 4240-00-770-0268 Hose, Airline Mask
NSN 4240-00-770-0269 Filter
NSN 4240-00-770-0270 Cartridge
**NSN 4240-01-022-1541 Submarines (Demand
Regulating Mask)**
NSN 4240-01-053-4228 Manifold, Double Outlet
**NSN 4240-01-104-5402 Surface Ships (Pressure Demand
Regulating Mask)**
NSN 4720-00-245-2304 Extension Hose (25 ft)
NSN 4730-01-009-9520 Fitting (male)

WT. 5.1 lbs. = MASK VOL. 360.0 in³
2.8 lbs. = HOSE 504.0 in³

Helpful Hints: Deleted from Gas Free Engineering Kit.

OPERATIONAL TEST/CHECK KIT
FOR COMBUSTIBLE
GAS INDICATOR PORTABLE
NSN 6665-00-401-8500

WT. 5.0 lbs. VOL. 279.6 in.³

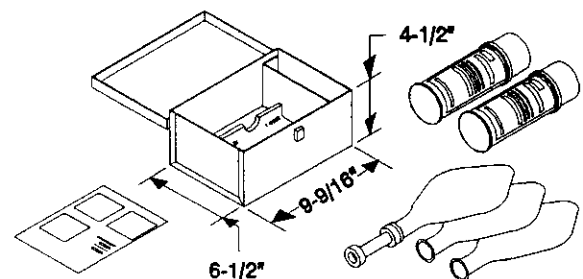

Helpful Hints: Deleted from Gas Free Engineering Kit.

DELETED ITEMS

Quantity
Required

**OPERATIONAL TEST/CHECK KIT -
MODEL 502**

1H 0000-LL-CQA-2495

WT. 5.0 lbs.

VOL. 262.0 in³

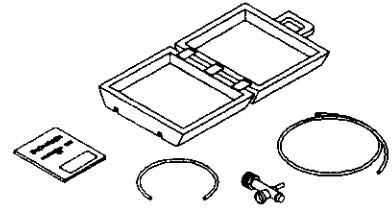

Helpful Hints: Utilize operational test/check kit that matches equipment manufacturer onboard. Deleted from Gas Free Engineering Kit.

PP-CANISTER - MASK MK V (C-1) (GREY SHIPPING CONTAINER)

5" x 3-1/2"

NSN 4240-00-218-0779

(CAN OF 2)

WT. 1.4 lbs

VOL. 66.0 in³

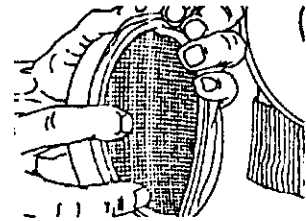
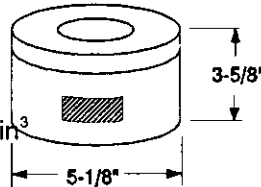

Helpful Hints: Deleted from Unit Patrol Locker and Unit Patrol Station.

**PP - CANISTER - OXYGEN GEN
(GREEN)**

NSN 4240-00-174-1365

WT. 4.0 lbs

VOL. 178.1 in³

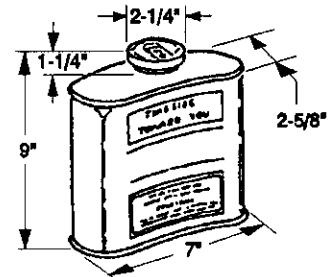

Helpful Hints: Deleted item from Investigator's Kit only.

DELETED ITEMS

Quantity
Required

PP-HELMET - BATTLE

1HS0000-LL-CJ7-5888

WT. 3.0 lbs VOL. 1,025.4 in³

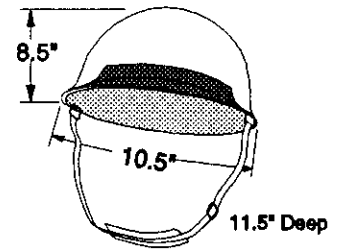

Helpful Hints: Deleted from AELs:

2-880044200	1 each
2-880044201	1 each
2-880044202	1 each
2-880044203	as required
2-880044204	as required
2-880044205	as required
2-880044206	as required
2-880044207	as required

Replaced by FF helmets for all repair party personnel - for 1-7 DCRS ships. Ships with 8-10 DCRSs will receive full outfitting as NAVSEA funds are available.

RAKE - OVERHAUL

MANUFACTURED BY SHIP'S FORCE

REFER TO DWG NO: 804-5959242

GEN NOTE: IAW WITH NAVSEA "COAT HANDLE FROM TOP UP TO AND INCLUDING BRACKET WITH PLASTISOL IAW W/MIL-P-20689 TO IMPROVE GRIP AND TO PROVIDE ELECTRICAL INSULATION"

1HS0000-LL-CJ7-5891

WT. 12.0 lbs. VOL. 60.0 in³

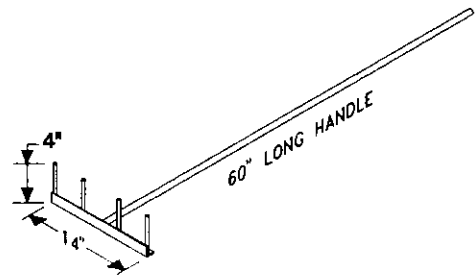

Helpful Hints: Deleted as replacement overhaul rake is received.

TERMINAL - QDSCNT

NSN 5940-00-196-2287

WT. 0.2 oz VOL. 1.6 in³

Helpful Hints: Deleted from Welding Kit.

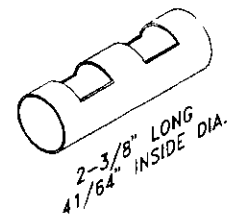

DELETED ITEMS

Quantity
Required

TOOL BOX - PORTABLE
22" x 8-1/2" x 9-1/2"

NSN 5140-00-315-2758

WT. 11.0 lbs **VOL.** 1,776.5 in³

Helpful Hints: Deleted from LP Air Kit.

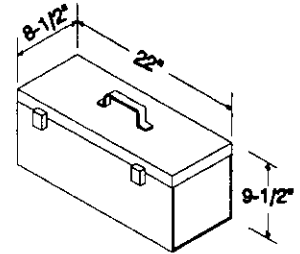

WATER-JEL
FIRE BLANKET

NSN: 9M 6510-01-242-2271

Helpful Hints: Deleted from NDI equipment.



WIRE ROPE ASSEMBLY -
(OBA TENDING LINE)
3/16" DIAMETER AND 50' LONG
EQUIPPED WITH SHANK HOOK EACH END

NSN 4010-00-285-9901

WT. 6.0 lbs **VOL.** 275.0 in³

Helpful Hints: Deleted from Investigator's Kit, Repair Locker Tool Kit and Rescue and Assistance Kit.

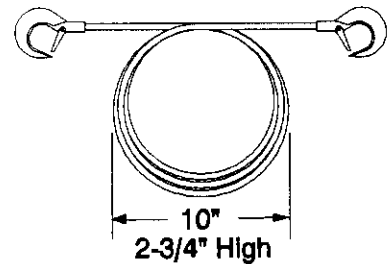

DELETED ITEMS

Quantity
Required

**WRENCH SET - SOCKET 3/8" DRIVE
23 PC SET**

NSN 5120-00-322-6231

WT. 10.0 lbs VOL. 328.0 in³

Helpful Hints: Deleted from DCPO Kit.

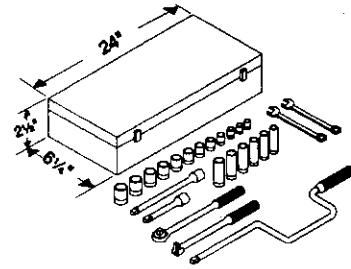

**INVENTORY AID BOOKLET
for
DAMAGE CONTROL EQUIPMENT**

RECOMMENDATION/SUGGESTION FORM

In the interest of continually improving the Inventory Aid Booklet for Damage Control Equipment, we would like to receive your suggestions for making this document a more effective tool for Navy personnel. To ensure that your suggestions are processed quickly and fully, please forward each recommendation on a separate form, with the requested information filled out. New changes will be presented annually at the CNO's DC/FF Working Group. Thank you for your time and effort in helping us improve this booklet.

ORIGINATOR INFORMATION

Name: _____

Ship/Station: _____

Address: _____

Daytime Phone Number: _____

Date: _____

RECOMMENDATIONS/SUGGESTION

What is the latest change incorporated into your DCEIA? _____

Does this suggestion pertain to incorrect information currently contained in the DCEIA?
(Y or N). Circle one.

If yes, what page(s) and paragraph(s) contain the error? _____

Recommendation/Suggestion: _____

**MAIL COMMENTS TO:
COMMANDER
H. KUZMA 03G1
NAVAL SEA SYSTEMS COMMAND
2531 JEFFERSON DAVIS HWY
ARLINGTON, VA 22242-5160
CODE: NAVSEA 03G1**